

**DESCRIPTION**

This is a high speed InGaAs detector optimized for fiber optic applications requiring high Responsivity and a fast response time.

**FEATURES**

- High Responsivity
- High Electrical Bandwidth/Fast response time
- High Reliability/Hermetic Package
- 75 µm Diameter Active Area

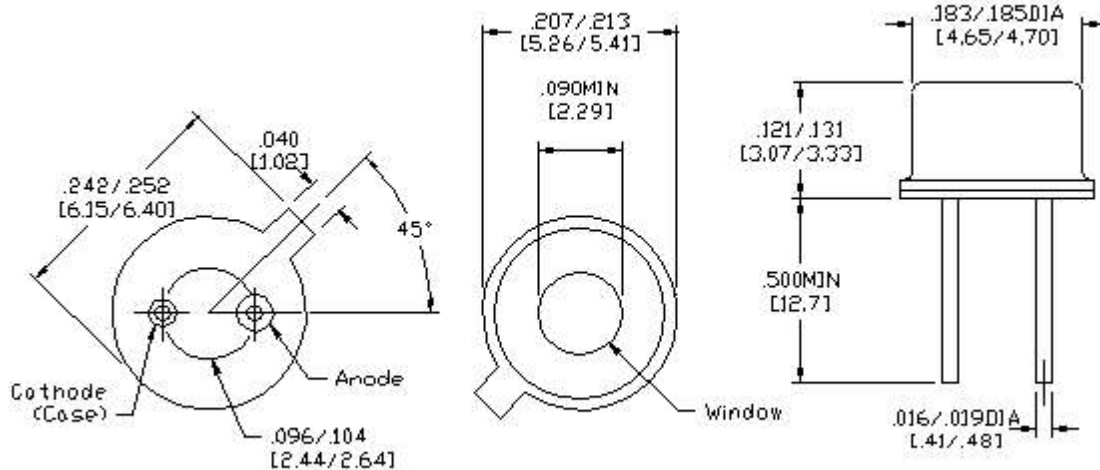

**ABSOLUTE MAXIMUM RATINGS**

- Storage temperature..... -55°C to +125°C
- Case operating temperature..... -40°C to +85°C
- Lead solder temperature..... 260°C, 10 seconds
- Reverse Breakdown Voltage..... 30 Volts
- Reverse Current..... 250 µA
- Forward Current..... 5 mA

**OUTLINE DIMENSIONS**

Tolerances are +/-0.005 inches, except as noted  
The case is electrically isolated from the pins.

PARAMETER	TEST CONDITION	SYMBOL	MIN	TYP	MAX	UNIT
Dark Current	Vr = 5 Volts, H = 0 mW	Id		1	5	nA
Capacitance	Vr = 0 V, f = 1 MHz	C		0.75	2.0	pF
Responsivity	Vr = 5 Volts λ = 1.31 µm	R <sub>c</sub>	.8	0.9		A/W
Responsivity	Vr = 5 Volts λ = 1.55 µm	R <sub>c</sub>	.9	1.05		A/W
Spectral Response		λ	800		1700	nm
Response Time	10%-90%, Vr = 5 Volts	t <sub>r</sub> t <sub>f</sub>		0.1 0.1		nsec nsec

**ELECTRO-OPTICAL CHARACTERISTICS (Case T = 25°C)**

distributed by