

Deep UV LED - 275nm

**UV CA3535 series (CUD7GF1B)**

**CUD7GF1B**

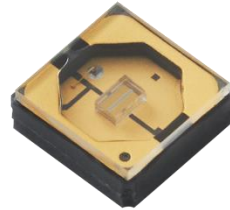

## Product Brief

### Description

CUD7GF1B is a deep ultraviolet light emitting diode with peak emission wavelengths from 270nm to 278nm.

The LED is sealed in Ceramic packages including an optical transparent window.

It incorporates state of the art SMD design and low thermal resistance.

CUD7GF1B is designed for air and water sterilization and tools including chemical and biological analysis in that spectral range.

### Features and Benefits

- Deep ultraviolet LED
- Low thermal resistance
- SMT solderable
- Lead Free product
- RoHS compliant

### Key Applications

- Disinfection
- Fluorescent spectroscopy
- Chemical and Biological analysis

Distributed by



Ohmstrasse 4 85716 Unterschleissheim Germany  
Tel.: +49 89 / 3214120 Fax: +49 89 / 32141211

[www.imm-photonics.de](http://www.imm-photonics.de)  
[sales@imm-photonics.de](mailto:sales@imm-photonics.de)

# Table of Contents

## Index

- Product Brief
- Table of Contents
- Performance Characteristics
- Characteristics Graph
- Binning Structure
- Mechanical Dimensions
- Recommended Solder Pad
- Reflow Soldering Characteristics
- Emitter Tape & Reel Packaging
- Product Nomenclature (Labeling Information)
- Reliability
- Handling of Silicone Resin for LEDs
- Precaution for Use
- Company Information

Distributed by



Ohmstrasse 4 85716 Unterschleissheim Germany  
Tel.: +49 89 / 3214120 Fax: +49 89 / 32141211

[www.imm-photonics.de](http://www.imm-photonics.de)  
[sales@imm-photonics.de](mailto:sales@imm-photonics.de)

## Performance Characteristics

**Table 1. Electro - Optical characteristic at 100mA**

 (T<sub>s</sub>=25°C, RH=30%)

Parameter	Symbol	Value	Unit
Peak wavelength <sup>[1]</sup>	$\lambda_p$	275	nm
Radiant Flux <sup>[2]</sup>	$\Phi_e$ <sup>[3]</sup>	11.5	mW
Forward Voltage <sup>[4]</sup>	V <sub>F</sub>	5.6	V
Spectrum Half Width	$\Delta \lambda$	11	nm
Radiation Angle	$\Theta$	125	deg.

**Table 2. Absolute Maximum Rating**

Parameter	Symbol	Value			Unit
		Min.	Typ.	Max.	
Forward Current	I <sub>F</sub>	20	100	250	mA
Junction Temperature	T <sub>j</sub>	-	-	120	°C
Storage Temperature	T <sub>stg</sub>	- 40	-	100	°C
Thermal resistance (J to S) <sup>[5]</sup>	R $\theta_{J-S}$	-	19	-	°C/W

### Notes :

1. Peak Wavelength Measurement tolerance :  $\pm 3$ nm
  2. Radiant Flux Measurement tolerance :  $\pm 10\%$
  3.  $\Phi_e$  is the Total Radiant Flux as measured with an integrating sphere.
  4. Forward Voltage Measurement tolerance :  $\pm 3\%$
  5. R $\theta_{J-S}$  is the thermal resistance between chip junction to solder. Cathode solder joint was used as a measurement of solder joint temperature(T<sub>s</sub>).  
Using metal PCB (Dielectric 2W/m·K layer and 2oz of cladding Cu)
- Calculated performance values are for reference only.
  - All measurements were made under the standardized environment of Seoul Viosys.
  - Thermal resistance can be increased substantially depending on the heat sink design/operating condition, and the maximum possible driving current will decrease accordingly.

Distributed by  IMM photonics

Ohmstrasse 4 85716 Unterschleissheim Germany  
Tel.: +49 89 / 3214120 Fax: +49 89 / 32141211

www.imm-photonics.de  
sales@imm-photonics.de

## Characteristics Graph

Fig 1. Spectrum,  $T_s=25^\circ\text{C}$ ,  $I_F=100\text{mA}$

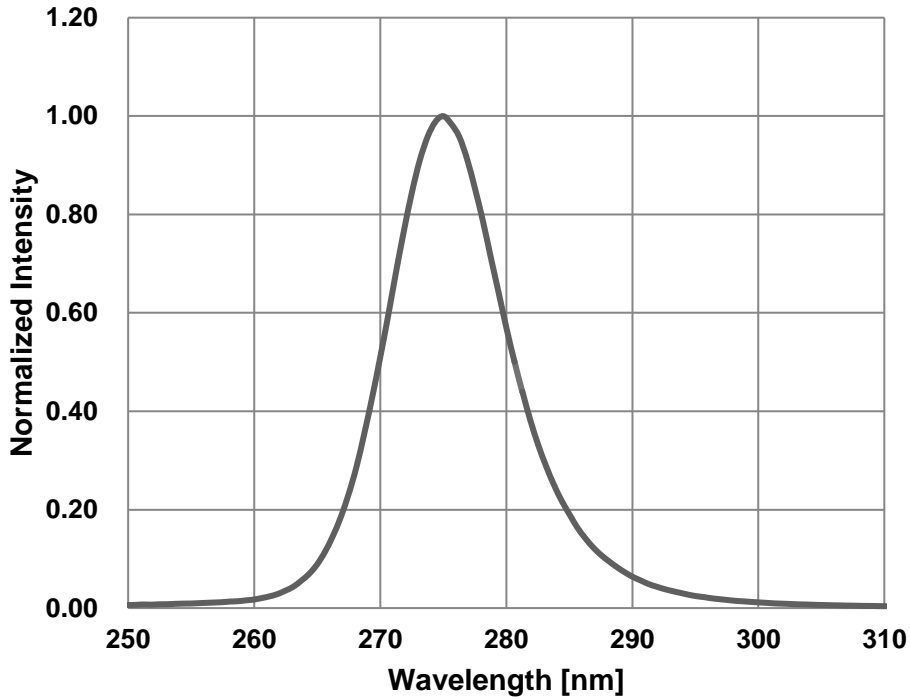
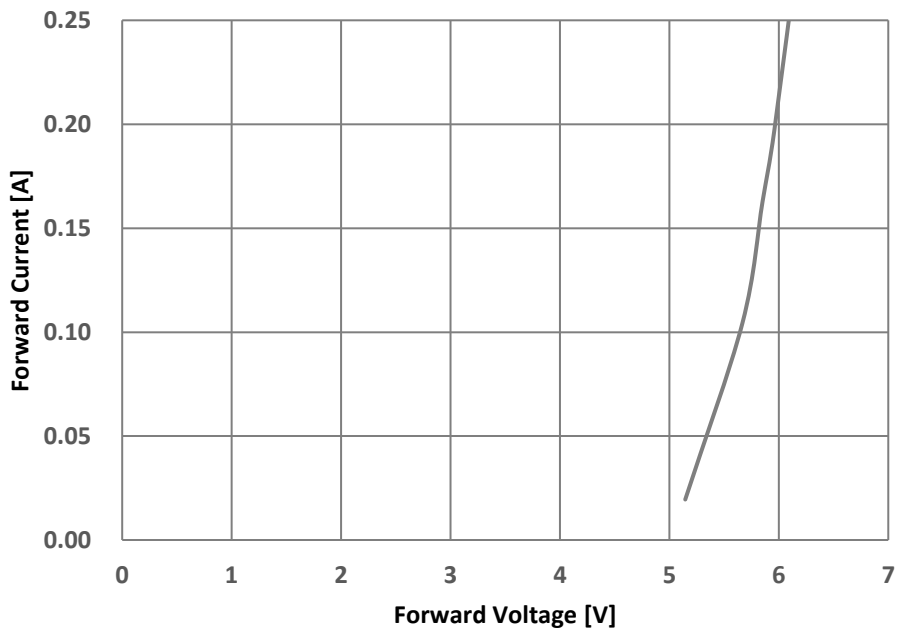

Fig 2. Forward Voltage vs. Forward Current,  $T_s=25^\circ\text{C}$



## Characteristics Graph

Fig 3. Forward Current vs. Relative Radiant Flux,  $T_s=25^\circ\text{C}$

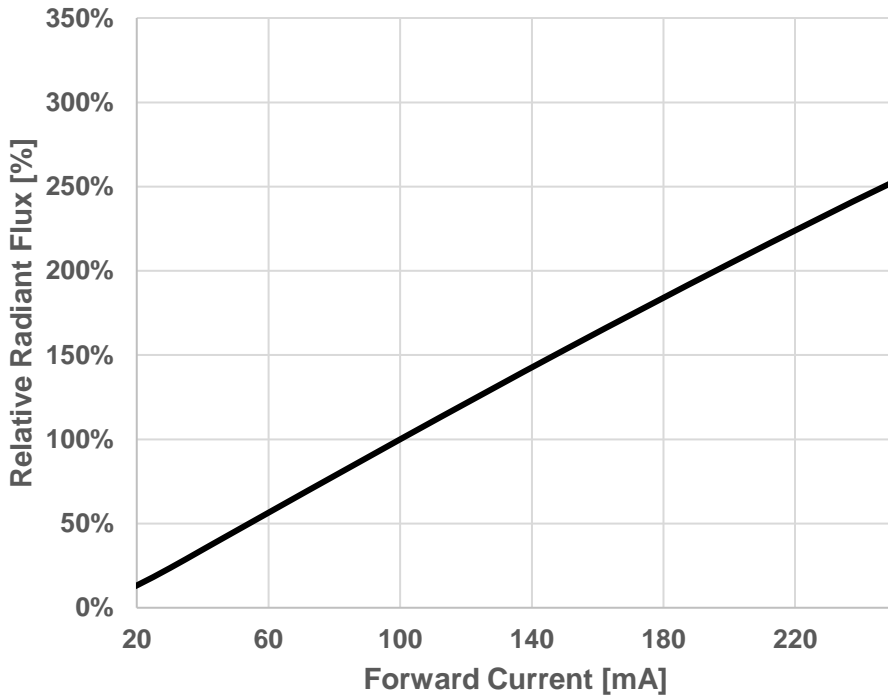
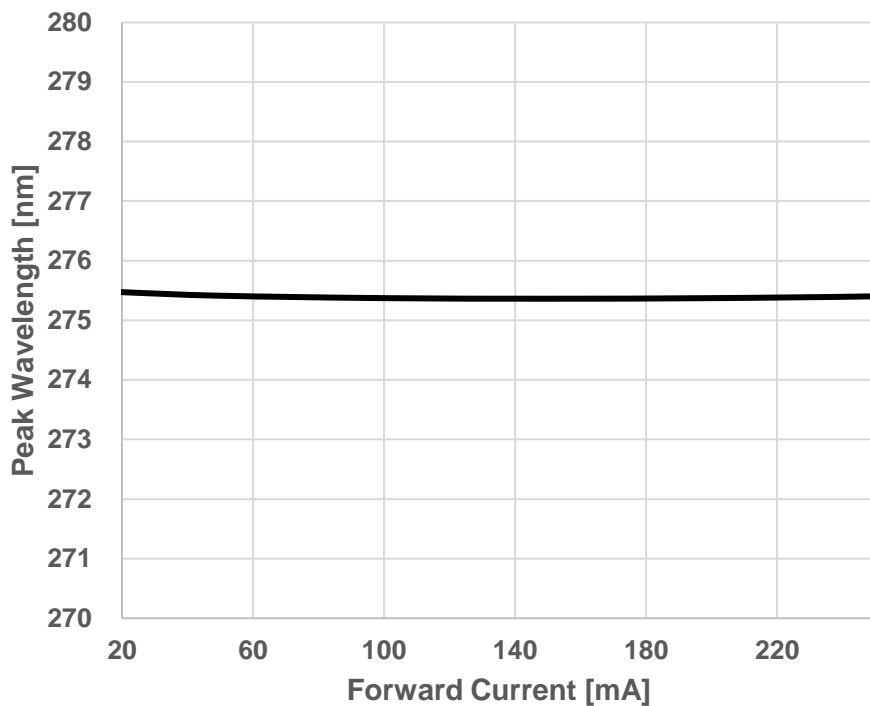

Fig 4. Forward Current vs. Peak Wavelength,  $T_s=25^\circ\text{C}$



## Characteristics Graph

Fig 5. Solder Joint Temperature vs. Relative Radiant Flux,  $I_F=100\text{mA}$

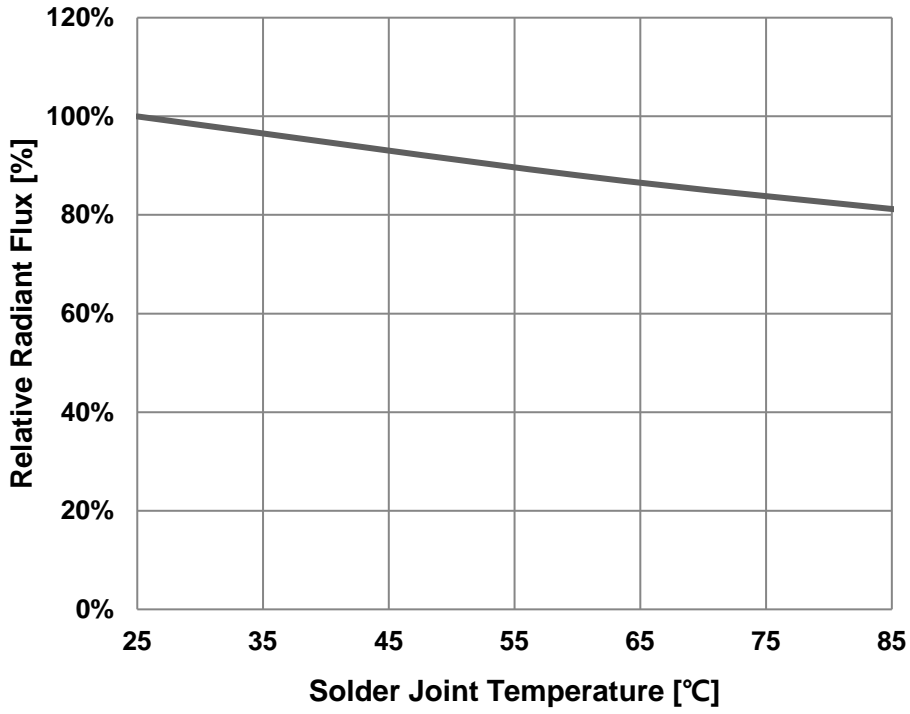
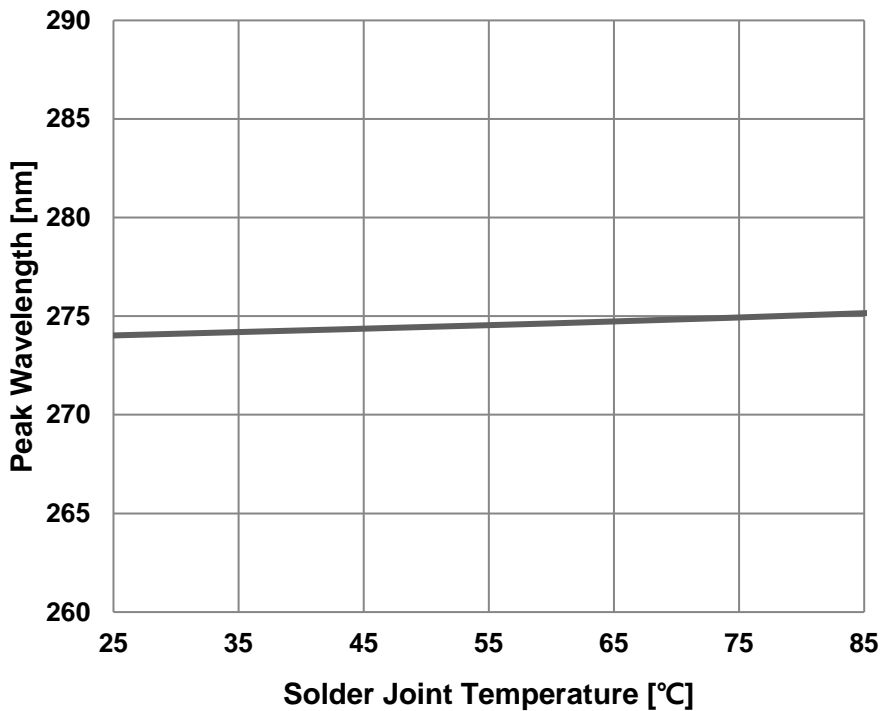

Fig 6. Solder Joint Temperature vs. Peak Wavelength,  $I_F=100\text{mA}$



## Characteristics Graph

Fig 7. Solder Joint Temperature vs. Forward Voltage,  $I_F=100\text{mA}$

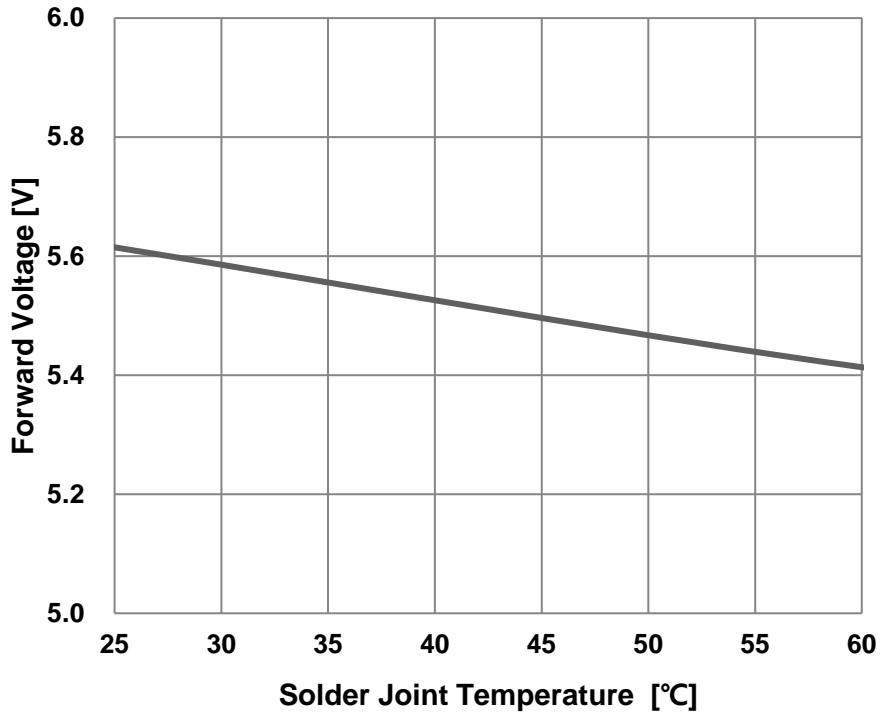
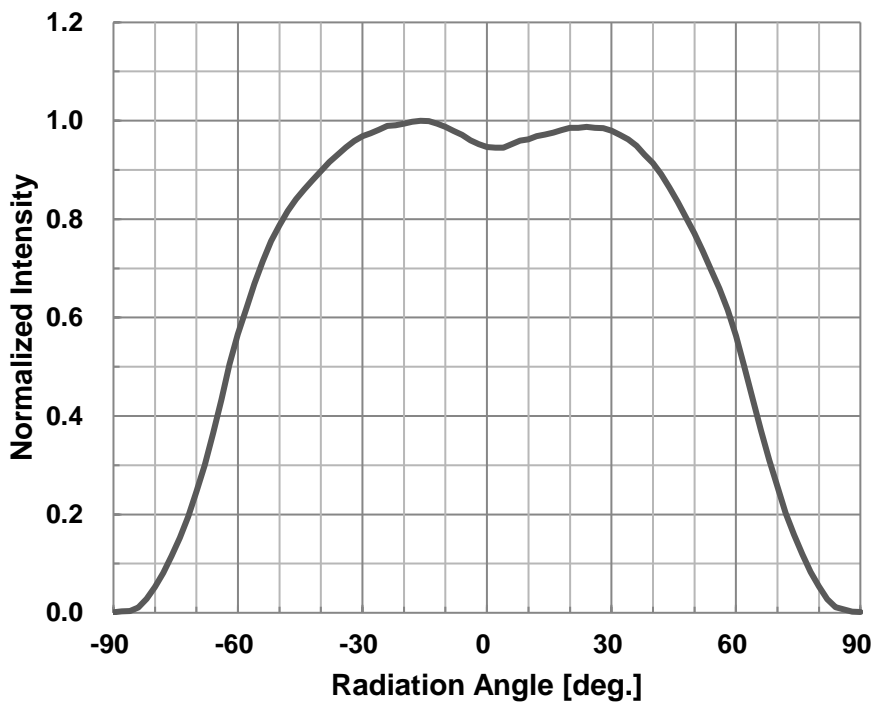

Fig 8. Typical Spatial Distribution,  $I_F=100\text{mA}$



## Binning Structure

Table 3. Binning Structure ,  $I_F=100\text{mA}$

$Y_1Y_2$			$Y_3Y_4Y_5$			$Y_6$		
Wp [nm]			Radiant Flux [mW]			Vf [V]		
BIN	MIN	MAX	BIN	MIN	MAX	BIN	MIN	MAX
c2	270	278	B06	6	8	V50	5.0	5.2
			B08	8	10	V52	5.2	5.4
			B10	10	12	V54	5.4	5.6
			B12	12	14	V56	5.6	5.8
			B14	14	16	V58	5.8	6.0
			B16	16	18	V60	6.0	6.2
						V62	6.2	6.4
						V64	6.4	6.6
						V66	6.6	6.8
						V68	6.8	7.0

Table 4. Ranks :

Binning Code	Description	Unit
$Y_1Y_2$	Peak Wavelength	nm
$Y_3Y_4Y_5$	Radiant Flux	mW
$Y_6$	Forward Voltage	V

Notes :

1. Peak Wavelength Measurement tolerance :  $\pm 3\text{nm}$
2. Radiant Flux Measurement tolerance :  $\pm 10\%$
3. Forward Voltage Measurement tolerance :  $\pm 3\%$

- All measurements were made under the standardized environment of Seoul Viosys.

Distributed by  IMM photonics

Ohmstrasse 4 85716 Unterschleissheim Germany  
Tel.: +49 89 / 3214120 Fax: +49 89 / 32141211

www.imm-photonics.de  
sales@imm-photonics.de



## Mechanical Dimensions

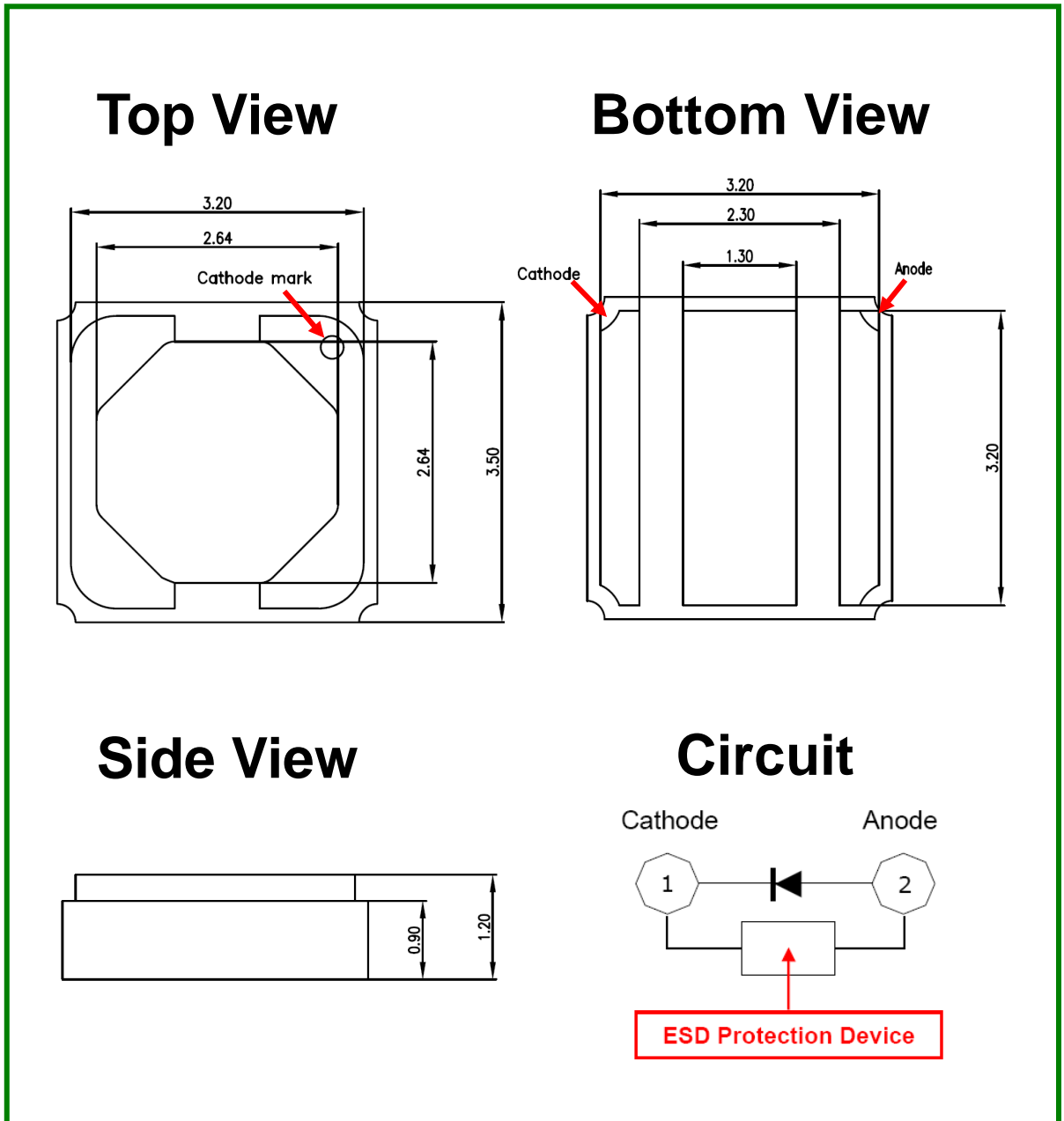

Notes :

- [1] All dimensions are in millimeters.
- [2] Scale : none
- [3] Undefined tolerance is  $\pm 0.2\text{mm}$

Distributed by  IMM photonics

Ohmstrasse 4 85716 Unterschleissheim Germany  
Tel.: +49 89 / 3214120 Fax: +49 89 / 32141211

www.imm-photonics.de  
sales@imm-photonics.de

## Recommended Solder Pad

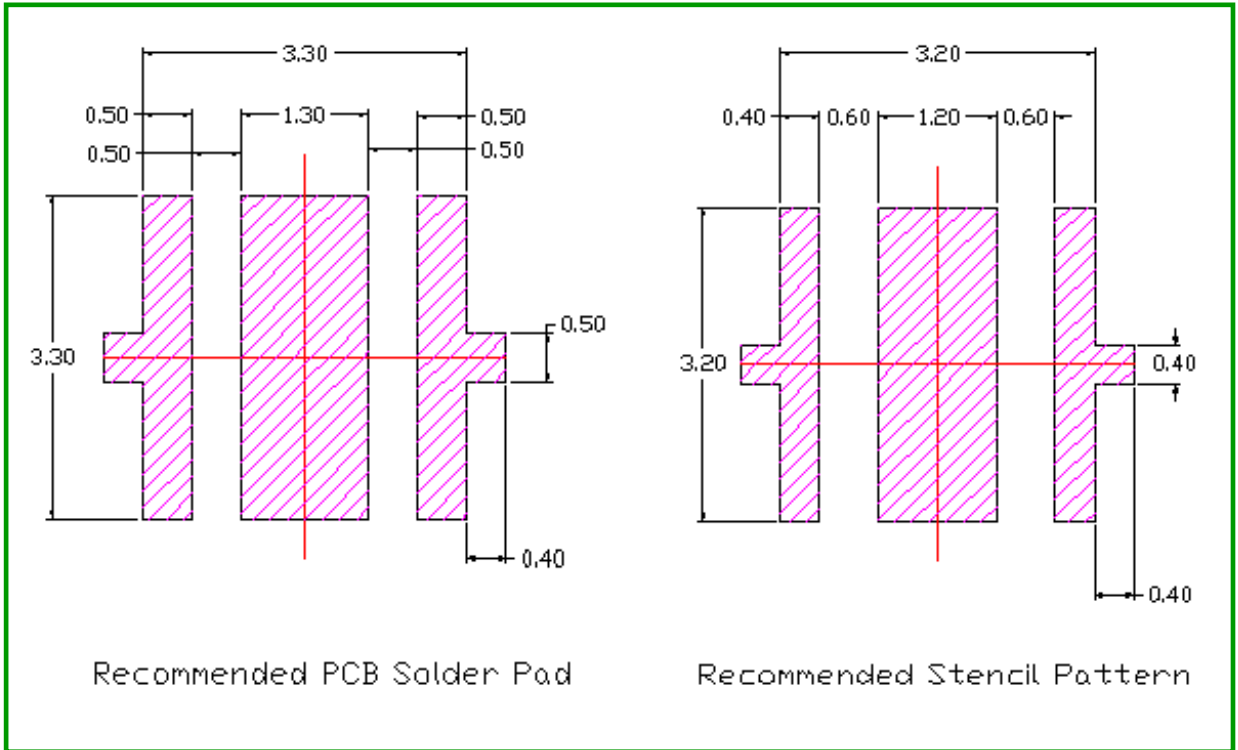

Notes :

- [1] All dimensions are in millimeters.
- [2] Scale : none
- [3] This drawing without tolerances is for reference only

Distributed by



Ohmstrasse 4 85716 Unterschleissheim Germany  
 Tel.: +49 89 / 3214120 Fax: +49 89 / 32141211

[www.imm-photonics.de](http://www.imm-photonics.de)  
[sales@imm-photonics.de](mailto:sales@imm-photonics.de)

## Reflow Soldering Characteristics

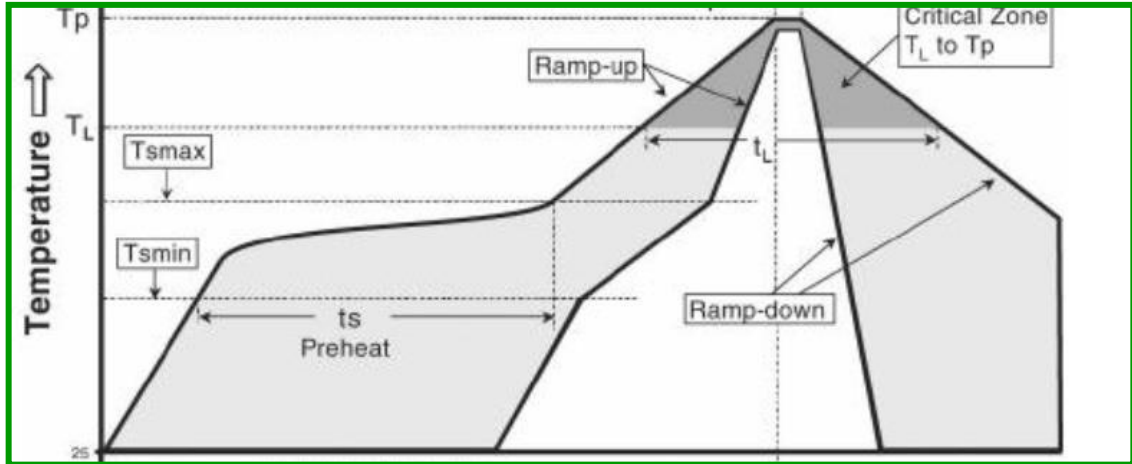

Profile Feature	Sn-Pb Eutectic Assembly	Pb-Free Assembly
Average ramp-up rate ( $T_{s\_max}$ to $T_p$ )	3° C/second max.	3° C/second max.
Preheat		
- Temperature Min ( $T_{s\_min}$ )	100 °C	150 °C
- Temperature Max ( $T_{s\_max}$ )	150 °C	200 °C
- Time ( $T_{s\_min}$ to $T_{s\_max}$ ) ( $t_s$ )	60-120 seconds	60-180 seconds
Time maintained above:		
- Temperature ( $T_L$ )	183 °C	217 °C
- Time ( $t_L$ )	60-150 seconds	60-150 seconds
Peak Temperature ( $T_p$ )	215°C	260°C
Time within 5°C of actual Peak Temperature ( $t_2$ )	10-30 seconds	20-40 seconds
Ramp-down Rate	6 °C/second max.	6 °C/second max.
Time 25°C to Peak Temperature	6 minutes max.	8 minutes max.

### Caution

1. Reflow soldering is not recommended to be done more than twice. In the case of second soldering it should be done within 24 hours after first soldering.
2. Die slug should be soldered.
3. Do not put a stress on the LEDs during soldering.
4. Do not bend the circuit board after soldering.

Distributed by  IMM photonics

Ohmstrasse 4 85716 Unterschleissheim Germany  
Tel.: +49 89 / 3214120 Fax: +49 89 / 32141211

www.imm-photonics.de  
sales@imm-photonics.de

## Emitter Tape & Reel Packaging

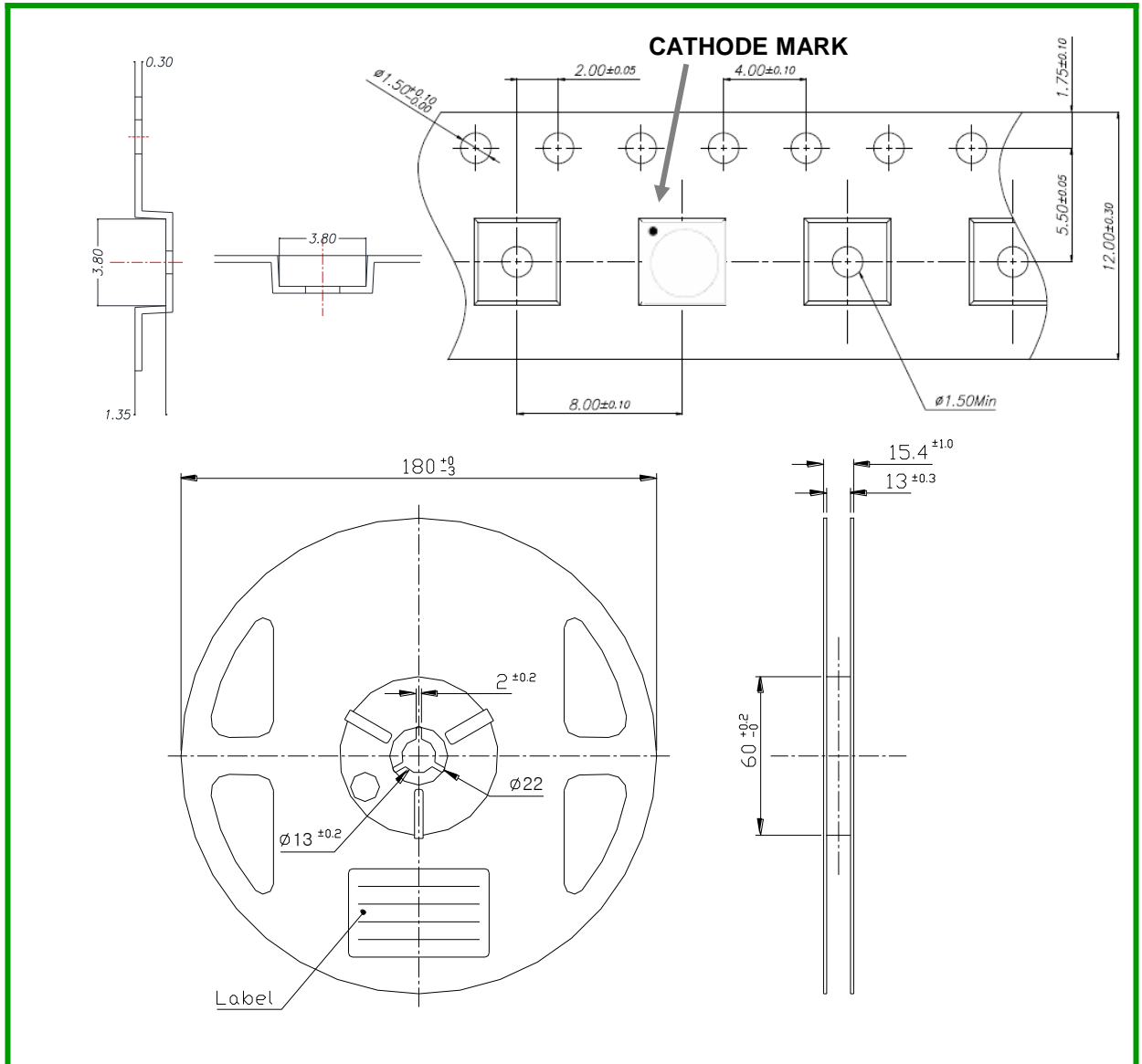

### Notes:

- 1.Quantity : 500pcs/Reel
- 2.Cumulative Tolerance : Cumulative Tolerance/10 pitches to be  $\pm 0.2\text{mm}$
- 3.Adhesion Strength of Cover Tape : Adhesion strength to be 10-60g when the cover tape is turned off from the carrier tape at the angle of  $10^\circ$  to the carrier tape

Distributed by  IMM photonics

Ohmstrasse 4 85716 Unterschleissheim Germany  
Tel.: +49 89 / 3214120 Fax: +49 89 / 32141211

www.imm-photonics.de  
sales@imm-photonics.de

## Emitter Tape & Reel Packaging

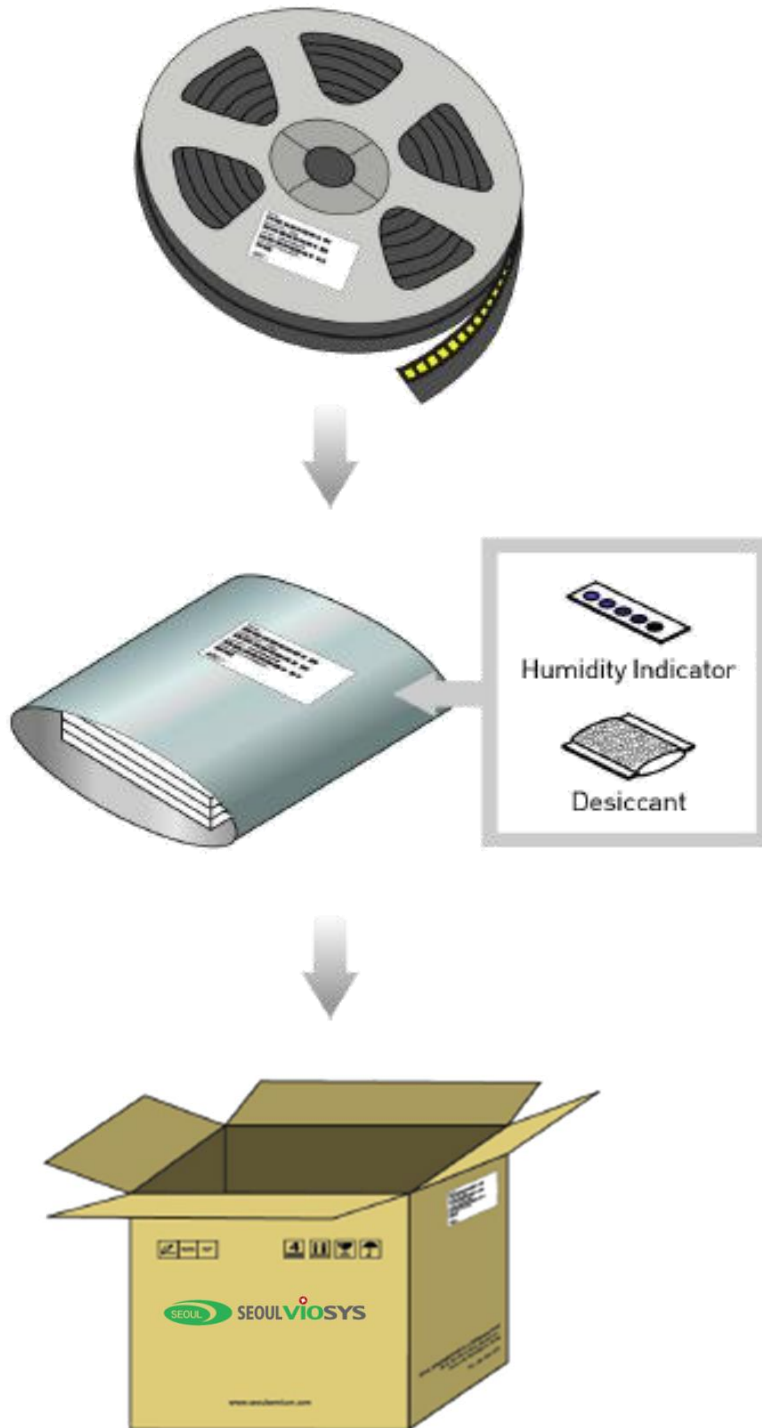

## Product Nomenclature

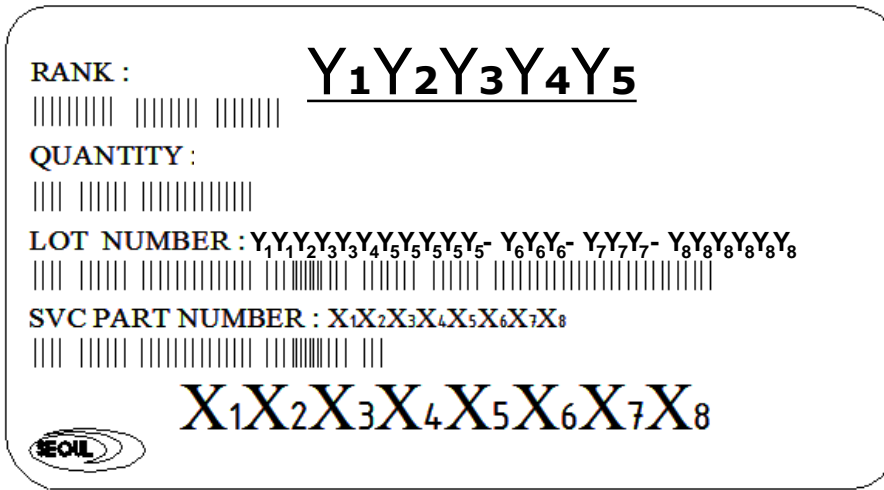

**Table 5. Part Numbering System: X<sub>1</sub>X<sub>2</sub>X<sub>3</sub>X<sub>4</sub>X<sub>5</sub>X<sub>6</sub>X<sub>7</sub>X<sub>8</sub>**

Part Number Code	Description	Part Number	Value
X <sub>1</sub>	Company	C	SVC
X <sub>2</sub>	UV LED	U	
X <sub>3</sub> X <sub>4</sub>	Wavelength	D7	Deep UV 275nm
X <sub>5</sub>	Package Series	G	CA3535
X <sub>6</sub>	Lens type	F	Flat window
X <sub>7</sub>	Chip Q'ty	1	1 chip
X <sub>8</sub>	Version	A	Ver0
		B	Ver1
		C	Ver2

**Table 6. Lot Numbering System: Y<sub>1</sub>Y<sub>2</sub>Y<sub>3</sub>Y<sub>4</sub>Y<sub>5</sub>Y<sub>5</sub>Y<sub>5</sub>Y<sub>5</sub>- Y<sub>6</sub>Y<sub>6</sub>- Y<sub>7</sub>Y<sub>7</sub>- Y<sub>8</sub>Y<sub>8</sub>Y<sub>8</sub>Y<sub>8</sub>**

Lot Number Code	Description
Y <sub>1</sub>	Year
Y <sub>2</sub>	Month
Y <sub>3</sub>	Day
Y <sub>4</sub>	Production area
Y <sub>5</sub>	Mass order
Y <sub>6</sub>	Taping number
Y <sub>7</sub>	Reel number
Y <sub>8</sub>	Internal management number

## Reliability Test

**Table 7. Test Result**

Test Item	Test Condition	Note	# Failed /Tested
Room Temp. Operational Life	Ta=25°C, IF=100mA	1000hrs	0/5
High Temperature Storage	Ta=100°C	500hrs	0/10
Low Temperature Storage	Ta=-40°C	500hrs	0/10
Thermal shock	Ta max=120°C, Ta min=-40°C 30min dwell/transfer time : 10sec, 1 cycle=1hr	200 cycles	0/22
Resistance to Soldering	Temp=260±5°C, Time : 10±1 sec	1 time	0/10
ESD	R=1.5kΩ, C=100pF Voltage level=2kV	3 times Negative /positive	0/22

**Table 8. Failure Criteria**

Parameter	Symbol	Test Conditions	Max. or Min. allowable shift value
Forward Voltage	$V_F$	IF=100mA	Max. Initial measurement x 1.2
Radiant Flux	$\Phi_e$	IF=100mA	Min. Initial measurement x 0.7

Notes :

1. The value is measured after the test sample is cooled down to the room temperature.

Distributed by



Ohmstrasse 4 85716 Unterschleissheim Germany  
Tel.: +49 89 / 3214120 Fax: +49 89 / 32141211

www.imm-photonics.de  
sales@imm-photonics.de

## Handling for LEDs

- (1) During processing, mechanical stress on the surface should be minimized as much as possible. Sharp objects of all types could crack the sealing compound.

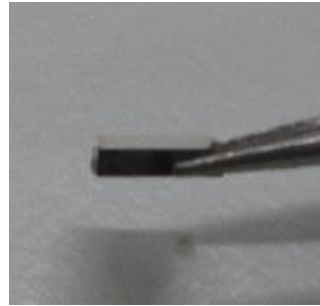

- (2) In general, LEDs should only be handled from the side. Grabbing the top window part could cause damaging or cracking of the window.
- (3) Glass can be damaged by force.
- Be careful not to touch the lens with tweezers or sharp tools. The lens can be shattered or fall apart.
  - The product can break when it falls.
  - If products were stacked after SMT, the product can be damaged.
- (4) Be careful with process that CA3535 series can be contaminated by foreign materials (particles, fume, gas, etc).
- (5) When populating boards in SMT production, there are basically no restrictions regarding the form of the pick and place nozzle, except that mechanical pressure on the surface of the resin must be prevented. This is assured by choosing a pick and place nozzle which is larger than the LED's reflector area.
- (6) This device is not allowed to be used in any type of fluid such as water, oil, organic solvent, etc. Ultrasonic cleaning is not recommended. Ultrasonic cleaning may cause damage to the LED.
- (7) Please do not mold this product into another resin (epoxy, urethane, etc) and do not handle this product with acid or sulfur material in sealed space.
- (8) Avoid leaving fingerprints on glass lens parts.

Distributed by



Ohmstrasse 4 85716 Unterschleissheim Germany  
Tel.: +49 89 / 3214120 Fax: +49 89 / 32141211

[www.imm-photonics.de](http://www.imm-photonics.de)  
[sales@imm-photonics.de](mailto:sales@imm-photonics.de)



## Precaution for Use

### (1) Storage

To avoid the moisture penetration, we recommend storing LEDs in a dry box with a desiccant . The recommended storage temperature range is 5°C to 30°C and a maximum humidity of RH50%.

### (2) Use Precaution after Opening the Packaging

Use proper SMD techniques when the LED is to be soldered dipped as separation of the lens may affect the light output efficiency.

Pay attention to the following:

- a. Recommend conditions after opening the package
  - Sealing / Temperature : 5 ~ 30°C Humidity : less than RH60%
- b. If the package has been opened more than 7days (MSL 3) or the color of the desiccant changes, components should be dried for 10-24hr at 65±5°C
- c. Baking should only be done once.

(3) Do not apply mechanical force or excess vibration during the cooling process to normal temperature after soldering.

(4) Do not rapidly cool device after soldering.

(5) Components should not be mounted on warped (non coplanar) portion of PCB.

(6) Radioactive exposure is not considered for the products listed here in.

(7) This device should not be used in any type of fluid such as water, oil, organic solvent and etc. When washing is required, IPA (Isopropyl Alcohol) should be used.

(8) When the LEDs are in operation the maximum current should be decided after measuring the package temperature.

(9) LEDs must be stored in a clean environment. We recommend LEDs store in nitrogen-filled container.

(10) The appearance and specifications of the product may be modified for improvement without notice.

**Distributed by**



Ohmstrasse 4 85716 Unterschleissheim Germany  
Tel.: +49 89 / 3214120 Fax: +49 89 / 32141211

[www.imm-photonics.de](http://www.imm-photonics.de)  
[sales@imm-photonics.de](mailto:sales@imm-photonics.de)

## Precaution for Use

(11) VOCs (Volatile organic compounds) emitted from materials used in the construction of fixtures can penetrate silicone encapsulants of LEDs and discolor when exposed to heat and photonic energy. The result can be a significant loss of light output from the fixture. Knowledge of the properties of the materials selected to be used in the construction of fixtures can help prevent these issues.

(12) The slug is electrically isolated.

(13) Attaching LEDs, do not use adhesives that outgas organic vapor.

(14) The driving circuit must be designed to allow forward voltage only when it is ON or OFF. If the reverse voltage is applied to LED, migration can be generated resulting in LED damage.

(15) LEDs are sensitive to Electro-Static Discharge (ESD) and Electrical Over Stress (EOS). Below is a list of suggestions that Seoul Viosys purposes to minimize these effects.

### a. ESD (Electro Static Discharge)

Electrostatic discharge (ESD) is defined as the release of static electricity when two objects come into contact. While most ESD events are considered harmless, it can be an expensive problem in many industrial environments during production and storage. The damage from ESD to LEDs may cause the product to demonstrate unusual characteristics such as:

- Increase in reverse leakage current lowered turn-on voltage
- Abnormal emissions from the LED at low current

The following recommendations are suggested to help minimize the potential for an ESD event. One or more recommended work area suggestions:

- Ionizing fan setup
- ESD table/shelf mat made of conductive materials
- ESD safe storage containers

One or more personnel suggestion options:

- Antistatic wrist-strap
- Antistatic material shoes
- Antistatic clothes

Environmental controls:

- Humidity control (ESD gets worse in a dry environment)

**Distributed by**



Ohmstrasse 4 85716 Unterschleissheim Germany  
Tel.: +49 89 / 3214120 Fax: +49 89 / 32141211

[www.imm-photonics.de](http://www.imm-photonics.de)  
[sales@imm-photonics.de](mailto:sales@imm-photonics.de)

## Precaution for Use

### b. EOS (Electrical Over Stress)

Electrical Over-Stress (EOS) is defined as damage that may occur when an electronic device is subjected to a current or voltage that is beyond the maximum specification limits of the device. The effects from an EOS event can be noticed through product performance like:

- Changes to the performance of the LED package  
(If the damage is around the bond pad area and since the package is completely encapsulated the package may turn on but flicker show severe performance degradation.)
- Changes to the light output of the luminaire from component failure
- Components on the board not operating at determined drive power

Failure of performance from entire fixture due to changes in circuit voltage and current across total circuit causing trickle down failures. It is impossible to predict the failure mode of every LED exposed to electrical overstress as the failure modes have been investigated to vary, but there are some common signs that will indicate an EOS event has occurred:

- Damaged may be noticed to the bond wires (appearing similar to a blown fuse)
- Damage to the bond pads located on the emission surface of the LED package  
(shadowing can be noticed around the bond pads while viewing through a microscope)
- Anomalies noticed in the encapsulation and phosphor around the bond wires.
- This damage usually appears due to the thermal stress produced during the EOS event.

### c. To help minimize the damage from an EOS event Seoul Viosys recommends utilizing:

- A surge protection circuit
- An appropriately rated over voltage protection device
- A current limiting device

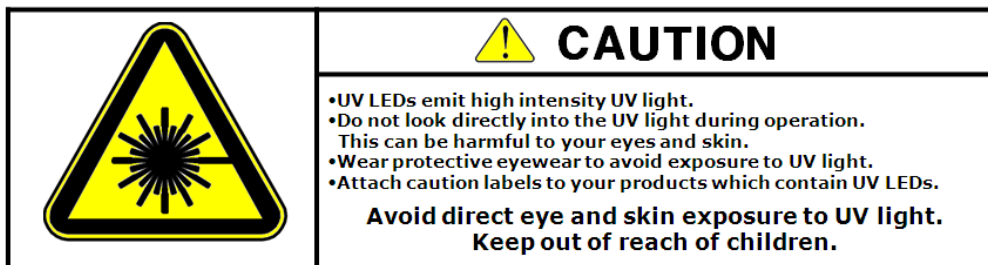

**Distributed by**



Ohmstrasse 4 85716 Unterschleissheim Germany  
Tel.: +49 89 / 3214120 Fax: +49 89 / 32141211

www.imm-photonics.de  
sales@imm-photonics.de

## Company Information

### Published by

Seoul Viosys © 2013 All Rights Reserved.

### Company Information

Seoul Viosys ([www.seoulviosys.com](http://www.seoulviosys.com)) manufactures light emitting diodes (LEDs) with a full range of UV wavelengths from UVC to UVA (under 400nm) for Industrial Curing, Air/Water Purification, Disinfection and Home appliance.

The company is one of the world leading UV LED supplier, holding more than 4,000 patents globally, while offering various kinds of LED technologies and application-solutions in High power UV LED, UV sensor, UV LED Lamp and variety of UV LED sourced Applications.

The company's broad product portfolio includes hybrid modules for unique applications such as UV disinfection, deodorization, UV purification as well as customized modules for your Application.

### Legal Disclaimer

Information in this document is provided in connection with Seoul Viosys products. With respect to any examples or hints given herein, any typical values stated herein and/or any information regarding the application of the device, Seoul Viosys hereby disclaims any and all warranties and liabilities of any kind, including without limitation, warranties of non-infringement of intellectual property rights of any third party. The appearance and specifications of the product can be changed to improve the quality and/or performance without notice.

### Distributed by



Ohmstrasse 4 85716 Unterschleissheim Germany  
Tel.: +49 89 / 3214120 Fax: +49 89 / 32141211

[www.imm-photonics.de](http://www.imm-photonics.de)  
[sales@imm-photonics.de](mailto:sales@imm-photonics.de)