

iC-PT H-Series

6-CH. PHASED ARRAY OPTO ENCODERS



Rev C2, Page 1/14

FEATURES

- ◆ Compact, high resolution incremental encoder ICs with up to 2048 CPR (native) and 8,192 CPR (interpolated)
- ◆ For code discs of $\varnothing 26$ mm, $\varnothing 33$ mm, $\varnothing 39$ mm
- ◆ Monolithic *HD Phased Array* with excellent signal matching
- ◆ Moderate track pitch for relaxed assembly tolerances
- ◆ Low-noise signal amplifiers with high EMI tolerance
- ◆ Pin-selectable operating modes: analog, compared (x1), interpolated (x2, x4)
- ◆ Pin-selectable index gating: ungated (1 T), B-gated (0.5 T), AB-gated (0.25 T)
- ◆ Complementary quadrature outputs: A, B, Z and NA, NB, NZ
- ◆ Commutation signal outputs: U, V, W
- ◆ Short-circuit-proof, current-limited, +/- 4 mA push-pull
- ◆ Analog signal output for ease of alignment and resolution enhancement by external interpolation
- ◆ LED power control with 40 mA high-side driver
- ◆ Low power consumption from single 3.5V to 5.5V supply
- ◆ Operating temperature range of -40 °C to +120 °C
- ◆ Evaluation kits with LED and code disc available for sampling

APPLICATIONS

- ◆ Incremental encoder
- ◆ Brushless DC motor commutation
- ◆ Industrial drives

PACKAGES

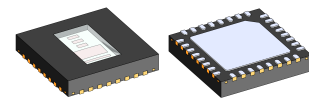

32-pin optoQFN
5 mm x 5 mm x 0.9 mm
RoHS compliant

BLOCK DIAGRAM

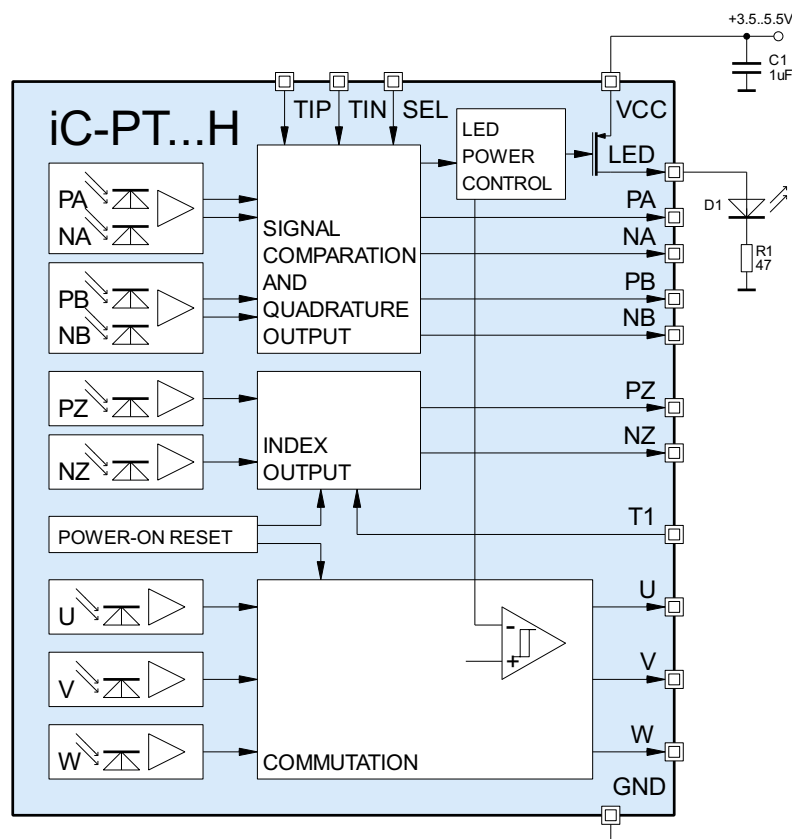

iC-PT H-Series

6-CH. PHASED ARRAY OPTO ENCODERS



Rev C2, Page 2/14

DESCRIPTION

The iC-PT H-series represents advanced optical encoder ICs featuring integrated photosensors arranged as an *HD Phased Array*, providing signal fidelity at relaxed alignment tolerances.

Its typical application are incremental encoders for motor speed control and commutation. To this end, the devices provide differential A/B tracks, a differential index track and three more tracks to generate block commutation signals.

Where the optical radius and the native cycles per revolution (CPR) are determined by the device version (refer to iC-PT26xxH, iC-PT33xxH, iC-PT39xxH details given further below), the adaption to the motor polecount is carried out by the code disc, for instance with 4 CPR and 90 degree phase shift to operate 4-phase brushless motors¹⁾.

Blue-enhanced photosensors allow the application of LEDs with short wavelength leading to an outstanding jitter performance due to improved signal contrast (recommended LED: iC-TL46). However, for most devices the photosensors are IR compatible as well (recommended LED²⁾: iC-TL85).

Low-noise transimpedance amplifiers, arranged in a paired layout to ensure excellent channel matching, are used to convert the scanner's signals into voltages of several hundred millivolts³⁾.

Precision comparators with hysteresis generate the digital signals subsequently, either native or interpolated, which are then output by differential ± 4 mA push-pull drivers.

The built-in averaging LED power controller with its 40 mA driver permits a direct connection of the encoder LED. The received optical power is kept con-

stant regardless of aging effects or changes in temperature.

Various operating modes are selectable at multi-level input SEL⁴⁾: digital output with native (x1) or interpolated resolution (x2 or x4), analog output or mixed analog/digital output; the latter combines an output of sine/cosine signals with compared UVW commutation signals. During analog operation the amplified signal voltages are available at the outputs for inspection and monitoring of encoder assembly, or to feed external interpolation circuits.

Index gating is also pin-selectable at input T1⁴⁾: the options are ungated, respectively T-gated if using interpolated output, B-gated and AB-gated.

All devices run at single-sided supplies from 3.5 V up to 5.5 V and feature a low power consumption.

iC-PT26xxH Series

Optical radius 11.0 mm, code disc \varnothing 26.0 mm;
Native CPR: 256, 500, 1000, 1250, 1500.

iC-PT33xxH Series

Optical radius 14.5 mm, code disc \varnothing 33.0 mm;
Native CPR: 360, 500, 1000, 1024, 1250, 1500, 1800 CPR.

For 2000, 2048, and 2500 CPR refer to iC-PT33xxH [Encoder blue](#)[®] Series.

iC-PT39xxH Series

Optical radius 17.5 mm, code disc \varnothing 39.0 mm;
Native CPR: 512, 1000, 1024, 2048.

¹⁾ Standard on code discs available for sampling.

²⁾ Except for [Encoder blue](#)[®] series: iC-PT3320H, PT3348H, PT3325H.

³⁾ Operating point varies by device version and CPR.

⁴⁾ For ease of replacement, iC-PT H-Series pin functions are backwards compatible to iC-PT series ICs.

Encoder blue is a trademark of iC-Haus GmbH.

PACKAGING INFORMATION

CHIP LAYOUT

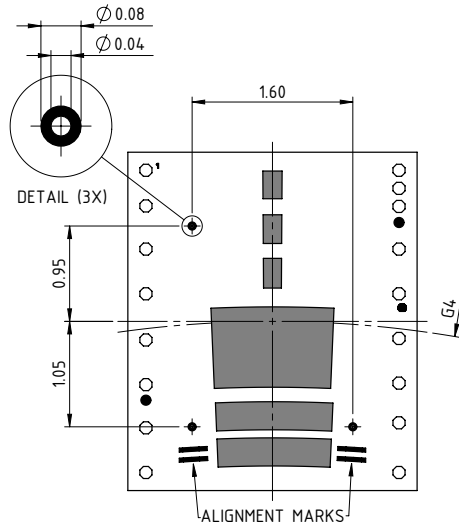

Chip layout example for chip release W2 and W3 featuring alignment markings.
Grey sections represent sensor layout areas; fill factors vary.

SENSOR LAYOUT

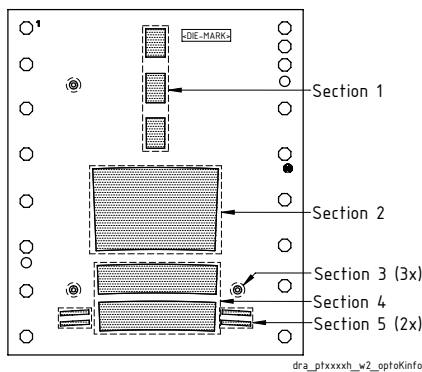

AOI CRITERIA

<Die Mark>	<Section>	<Area Class> ¹
iC PT2656H W3, iC PT2650H W3		
iC PT3304H W2, iC PT3350H W3, iC PT3912H W2	1, 4, 5	A40
	2, 3	A25
iC PT3310H W2, iC PT3324H W2, iC PT3313H W2	1, 4, 5	A40
	2, 3	A25
iC PT3910H W2, iC PT3924H W2	1, 4, 5	A40
	2, 3	A25
iC PT2610H W2, iC PT2613H W1		
iC PT3315H W2, iC PT3318H W2, iC PT3948H W2	1, 4, 5	A40
	2, 3	A25
iC-PT3320H ² , iC-PT3348H ² , iC-PT3325H ²		

¹ Selection class for the optical inspection of detector areas. Refer to [Optical Selection Criteria](#) for further description.

² Refer to iC-PT33xxH [Encoder blue](#)® Series datasheet available separately.

iC-PT H-Series

6-CH. PHASED ARRAY OPTO ENCODERS



Rev C2, Page 4/14

PIN CONFIGURATION

oQFN32-5x5 (5 mm x 5 mm)

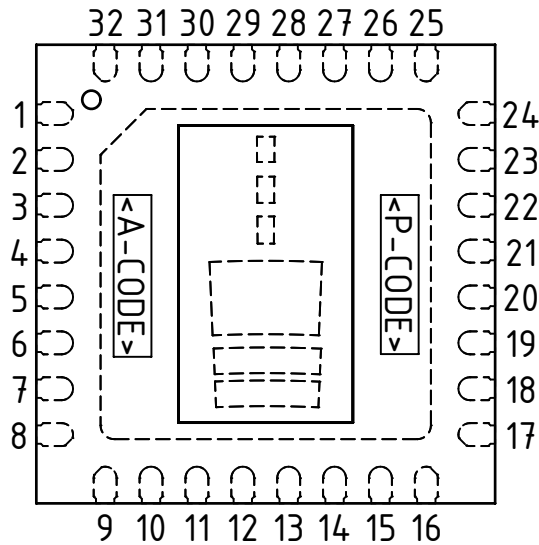

PIN FUNCTIONS

No.	Name	Function
1	VCC	+3.5 V...+5.5 V Supply Voltage
2	LED	LED Controller, High-Side Current Source Output
3	PA	Push-Pull Output A+ / Analog Sin+ ¹
4	NA	Push-Pull Output A- / Analog Sin-
5	PB	Push-Pull Output B+ / Analog Cos+
6	NB	Push-Pull Output B- / Analog Cos-
7	PZ	Push-Pull Output Z+ / Analog Z+
8	NZ	Push-Pull Output Z- / Analog Z-
9..16	n.c. ²	
17	SEL	Op. Mode Selection Input: 100% VCC = x2 interpolated 75% VCC = ABZ analog, UVW digital 50% VCC (or pin open) = all analog 25% VCC = x4 interpolated 0% VCC = x1 compared (native res.)
18	W	Push-Pull Output W / Analog W
19	TIN	Negative Test Current Input ³
20	V	Push-Pull Output V / Analog V
21	TIP	Positive Test Current Input ³
22	U	Push-Pull Output U / Analog U
23	T1	Index Gating Selection Input: lo = 0.5 T (B-gated), hi = 1 T (ungated/T-gated), open = 0.25 T (AB-gated)
24	GND	Ground
25..32	n.c.	
	BP	Backside Paddle ⁴

IC top marking: <P-CODE> = product code, <A-CODE> = assembly code (subject to changes);

¹ Capacitive pin loads must be avoided when using the analog output signals.

² Pin numbers marked n.c. are not connected.

³ The test pins TIP and TIN may remain unconnected.

⁴ Connecting the backside paddle is recommended by a single link to GND. A current flow across the paddle is not permissible.

iC-PT H-Series

6-CH. PHASED ARRAY OPTO ENCODERS



Rev C2, Page 5/14

PACKAGE DIMENSIONS

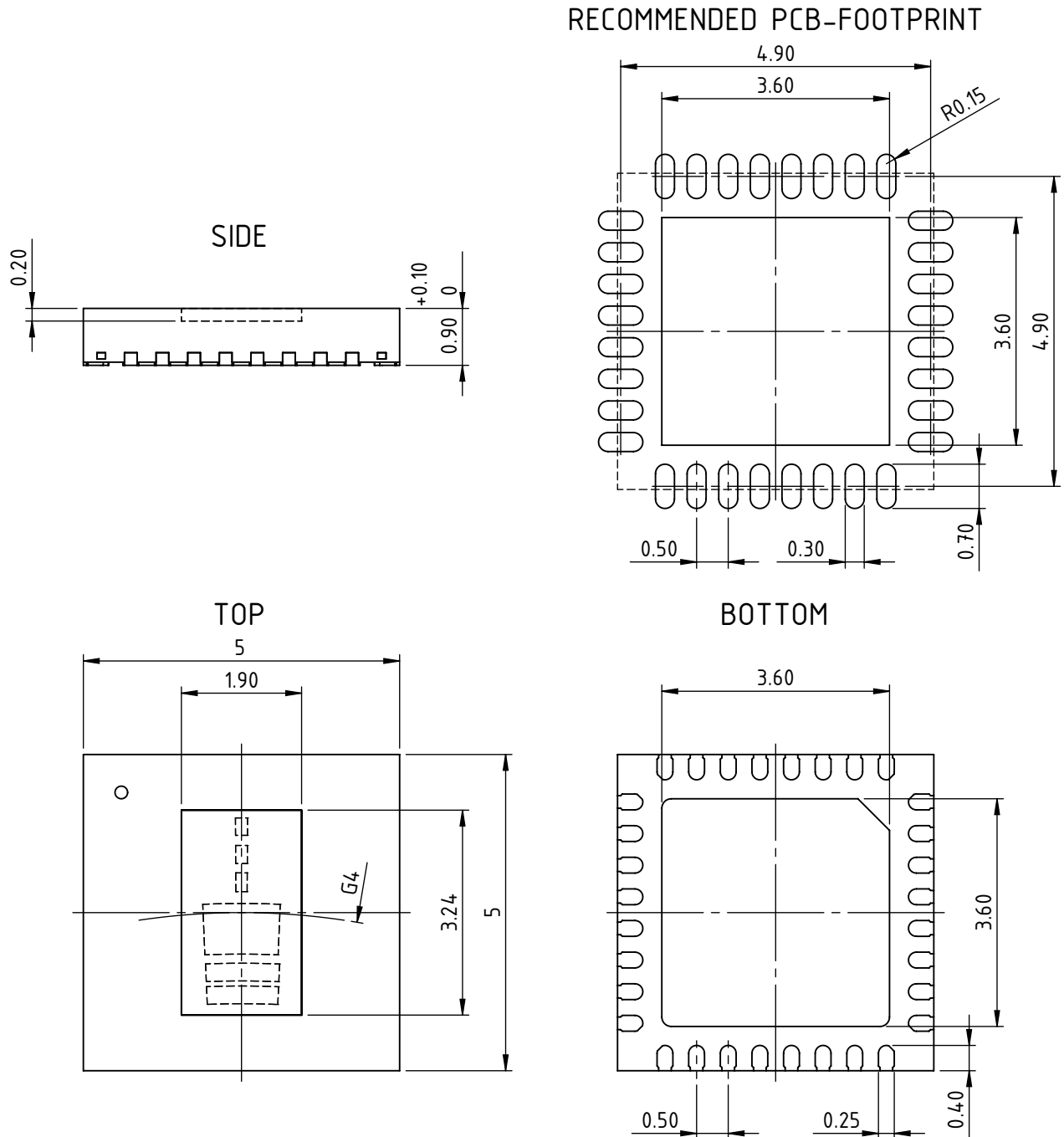

All dimensions given in mm. General Tolerances of form and position according to JEDEC MO-220.
 Positional tolerance of sensor pattern: $\pm 70\mu\text{m}$ / $\pm 1^\circ$ (with respect to center of backside pad).
 G4: radius of chip center (refer to the relevant encoder disc and code description).
 Maximum molding excess $+20\mu\text{m}$ / $-75\mu\text{m}$ versus surface of glass. Small pits in the mold surface, which may occasionally appear due to the manufacturing process, are cosmetic in nature and do not affect reliability.

iC-PT H-Series

6-CH. PHASED ARRAY OPTO ENCODERS



Rev C2, Page 6/14

ABSOLUTE MAXIMUM RATINGS

These ratings do not imply operating conditions; functional operation is not guaranteed. Beyond these ratings device damage may occur.

Item No.	Symbol	Parameter	Conditions			Unit
				Min.	Max.	
G001	VCC	Voltage at VCC		-0.3	6	V
G002	I(VCC)	Current in VCC		-20	170	mA
G003	V()	Voltage at all Pins		-0.3	VCC + 0.3	V
G004	I()	Current in PA, NA, PB, NB, PZ, NZ, U, V, W, TIP, TIN, SEL, T1		-20	20	mA
G005	I()	Current in LED		-120	20	mA
G006	Vd()	ESD Susceptibility, all pins	HBM, 100 pF discharged through 1.5 kΩ		2	kV
G007	Tj	Junction Temperature		-40	150	°C

THERMAL DATA

Operating conditions: VCC = 3.5...5.5 V

Item No.	Symbol	Parameter	Conditions				Unit
				Min.	Typ.	Max.	
T01	Ta	Operating Ambient Temperature Range		-40		120	°C
T02	Ts	Permissible Storage Temperature Range		-40		120	°C
T03	Tpk	Soldering Peak Temperature	tpk < 20 s, convection reflow tpk < 20 s, vapor phase soldering MSL 5A (max. floor life 24 h at 30 °C and 60 % RH); Please refer to customer information file No. 7 for details.			245 230	°C °C

All voltages are referenced to ground unless otherwise stated.

All currents flowing into the device pins are positive; all currents flowing out of the device pins are negative.

iC-PT H-Series

6-CH. PHASED ARRAY OPTO ENCODERS



Rev C2, Page 7/14

ELECTRICAL CHARACTERISTICS

Operating conditions: $V_{CC} = 3.5...5.5\text{ V}$, $T_j = -40...125\text{ °C}$, $\lambda_{LED} = \lambda_r = 740\text{ nm}$, unless otherwise noted

Item No.	Symbol	Parameter	Conditions				Unit
				Min.	Typ.	Max.	
Total Device							
001	VCC	Permissible Supply Voltage		3.5		5.5	V
002	I(VCC)	Supply Current	photocurrents within op. range, no load		6		mA
Photosensors							
101	λ_{ar}	Spectral Application Range	$Se(\lambda_{ar}) = 0.25 \times S(\lambda_{pk})$ Refer to iC-PTxxxxH Encoder blue® Series datasheet for iC-PT3320H, iC-PT3048H, and iC-PT3325H.	400		950	nm
Photocurrent Amplifiers							
201	Z()	Equivalent Transimpedance Gain	$Z = V_{out}() / I_{ph}()$, $T_j = 27\text{ °C}$; for PA, PB, NA, NB for PZ, NZ for U, V, W		0.5 1.25 2...3.3		M Ω M Ω M Ω
Analog Outputs: PA, NA, PB, NB, PZ, NZ, U, V, W							
301	Vout()mx	Permissible Maximum Output Voltage		1.8			V
303	Vout()ac	AC Signal Level	LED iC-TL85 LED iC-TL46		0.2...0.4 0.3...0.5		Vpp Vpp
304	Vout()d	Dark Signal Level	$I() < 10\text{ }\mu\text{A}$	560	770	985	mV
305	Ri()	Output Resistance		250	750	2250	Ω
306	Isc()hi	Short-Circuit Current hi	SEL open, load current to ground	300	1000	1700	μA
307	Isc()lo	Short-Circuit Current lo	SEL open, load current to IC	50	85	250	μA
Comparators							
401	Vt()hys	Switch Hysteresis			24		mV
LED Power Control							
501	Iop()	LED Output Current Control Range		0		40	mA
502	Ictrl()	Controlled LED Output Current	refer to Table 5 for details		5...12		mA
503	Vs()hi	Saturation Voltage hi	$Vs()_{hi} = V_{CC} - V(LED)$; $I() = -40\text{ mA}$			0.6	V
504	Isc()hi	Short-Circuit Current hi	$V() = 0\text{ V}$	-150		-50	mA
Digital Outputs: PA, NA, PB, NB, PZ, NZ, U, V, W							
601	fout	Maximum Output Frequency	x1 compared (native resolution) x2 interpolated x4 interpolated	400 800 1600			kHz kHz kHz
602	AArel	AB Duty Cycle Variation	AC signal according to item 303, compared or interpolated, see Figure 1	-10		10	%
603	Vs()lo	Saturation Voltage lo	$I() = 4\text{ mA}$			0.6	V
605	Isc()lo	Short-Circuit Current lo	$V() = V_{CC}$	7		70	mA
606	Vs()hi	Saturation Voltage hi	$Vs()_{hi} = V_{CC} - V()$, $I() = -4\text{ mA}$			0.6	V
608	Isc()hi	Short-Circuit Current hi	$V() = 0\text{ V}$	-70		-7	mA
Operating Mode Selection Input: SEL							
701	Vmod()	Mode Selection (see Figure 2)	x2 interpolated analog ABZ, digital UVW all analog x4 interpolated x1 compared (native resolution)	95 70 45 20 0		100 80 55 30 5	%VCC %VCC %VCC %VCC %VCC
702	Vmod()hys	Hysteresis			10		%VCC
704	V0()	Pin-Open Voltage		45	50	55	%VCC
705	Rpd()	Pull-Down Resistor	$V(SEL) = V_{CC}$	65			k Ω
706	Rpu()	Pull-Up Resistor	$V(SEL) = 0\text{ V}$	65			k Ω

iC-PT H-Series

6-CH. PHASED ARRAY OPTO ENCODERS



Rev C2, Page 8/14

ELECTRICAL CHARACTERISTICS

Operating conditions: $V_{CC} = 3.5...5.5\text{ V}$, $T_j = -40...125\text{ }^\circ\text{C}$, $\lambda_{LED} = \lambda_r = 740\text{ nm}$, unless otherwise noted

Item No.	Symbol	Parameter	Conditions	Min.	Typ.	Max.	Unit
Index Gating Selection Input: T1							
801	Vgate()	Gating Selection (see Figure 3)	ungated (1 T with interpolation) AB-gated (0.25 T) B-gated (0.5 T)	82 32 0		100 68 18	%VCC %VCC %VCC
802	Vgate()hys	Hysteresis			10		%VCC
804	V0()	Pin-Open Voltage	for index length 0.25 T (AB-gated)	45	50	55	%VCC
805	Rpd()	Pull-Down Resistor	$V(T1) = V_{CC}$	65			k Ω
806	Rpu()	Pull-Up Resistor	$V(T1) = 0\text{ V}$	65			k Ω
Test Inputs: TIP, TIN							
Z101	Ipd()	Pull-Down Current	test mode not active, $V() = 0.4\text{ V}$	60	100		μA
Z102	It(on)	Test Mode Activation Threshold			130	190	μA
Z103	V()test	Test Pin Operating Voltage	test mode active, $I() = 200\text{ }\mu\text{A}$		1.5		V
Z104	I()test	Permissible Test Current	test mode active	10		1000	μA
Z105	CR()	Current Ratio $I()_{\text{test}}/I_{\text{ph}}()$	test mode active, $I() = 200\text{ }\mu\text{A}$		1000		

ELECTRICAL CHARACTERISTICS: Diagrams

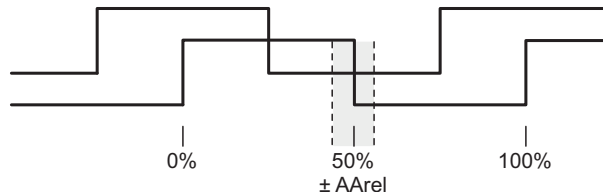

Figure 1: Definition of AB duty cycle variation.

1

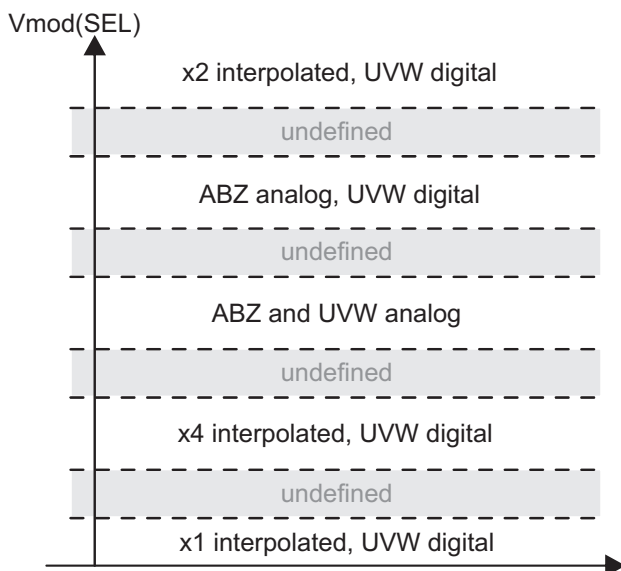

Figure 2: Operating mode selection at pin SEL.

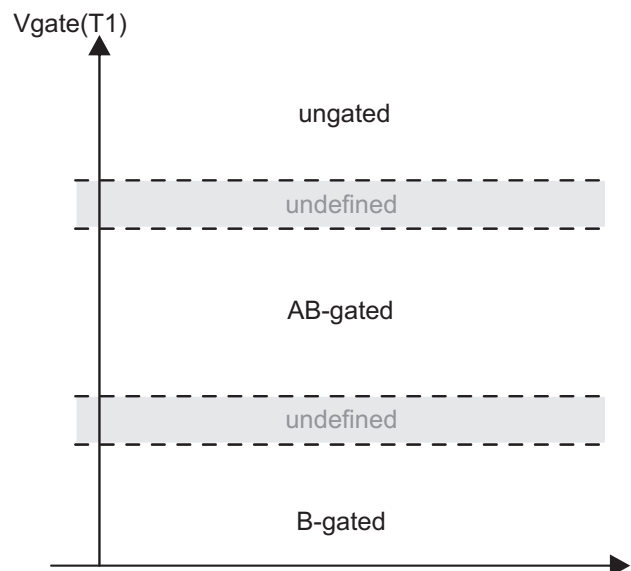

Figure 3: Index gating selection at pin T1.

DIGITAL OUTPUT SIGNALS

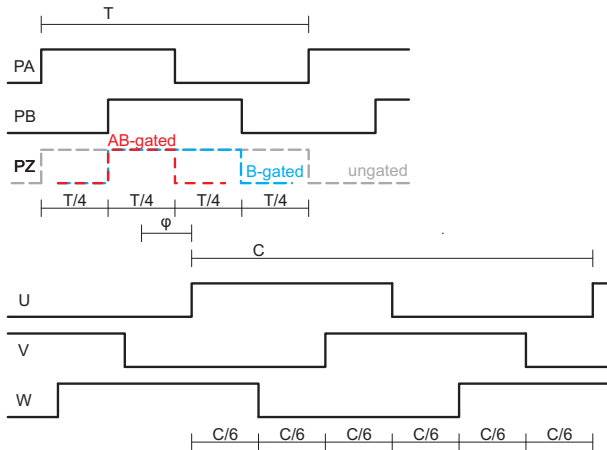

Figure 4: Encoder quadrature signals and motor commutation signals.

iC-PT H-series devices determine the optical radius and the native cycles per revolution for the quadrature outputs by its phased array design.

The U, V, W commutation signals can be configured independently of the device: the pulse count, period length and phase shift is determined by the code disc.

Standard code discs available for sampling provide 4 CPR each for U/V/W, with a period length of 90 degrees (C). A phase shift of 0 degrees (φ) between U and Z edges must be considered during alignment. Ideally, the rising edge of U meets the index Z.

For detailed specifications, refer to the relevant code disc datasheets, available separately.

ANALOG OUTPUT SIGNALS

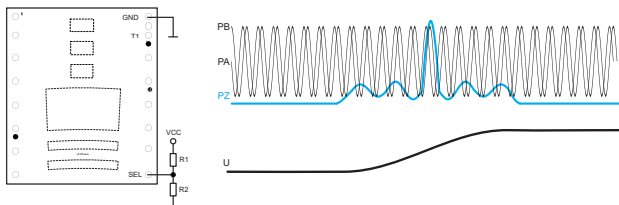

Figure 5: Example of analog ABZ / analog UVW (pin SEL = 50% VCC)

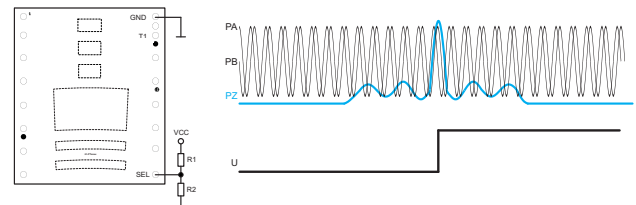

Figure 6: Example of analog ABZ / digital UVW (pin SEL = 75% VCC)

The iC-PT H-series features 5 principle operation modes which are selectable by the voltage applied to pin SEL. A voltage divider as suggested by Table 1 is the easiest way to obtain this.

SEL	R1 ¹⁾	R2 ¹⁾	Operation Mode
100 % VCC	0 Ω	open	x2 interpolated ABZ digital UVW
75 % VCC	2.7 k Ω	8.2 k Ω	analog ABZ digital UVW
50 % VCC	4.7 k Ω (open)	4.7 k Ω (open)	analog ABZ analog UVW
25 % VCC	8.2 k Ω	2.7 k Ω	x4 interpolated ABZ digital UVW
0 % VCC	open	0 Ω	x1 compared ABZ digital UVW

1) Exemplary values.

Table 1: Selection of operation mode by pin SEL.

If input SEL is left open, the IC biases its input at 50% VCC and analog output signals are available for test and alignment.

Analog output signals may also be used to increase the encoder's resolution by connecting an external interpolation IC. In this case the analog signals are required permanently, so that noise immunity should be improved by wiring pin SEL to an external reference providing VCC/2.

Setting 75 % VCC may be considered to obtain analog signals at PA/PB/PZ and NA/NB/NZ outputs feeding the external interpolation IC, together with digital signals at U/V/W directly connecting a line driver. Special attention to the PCB layout should be paid to avoid cross talk; analog and digital lines should be separated carefully.

INDEX GATING AND INTERPOLATION

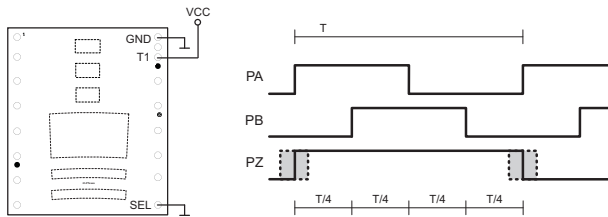

Figure 7: Ungated index ($T1 = \text{high}$),
x1 compared ($\text{SEL} = \text{low}$).

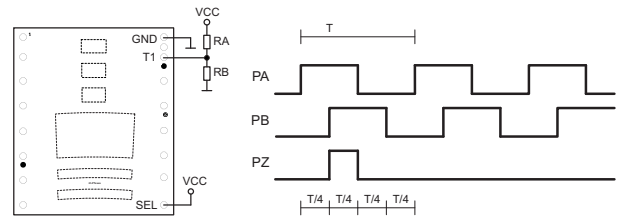

Figure 12: AB-gated index ($T1 = \text{open or } VCC/2$),
x2 interpolated ($\text{SEL} = \text{high}$).

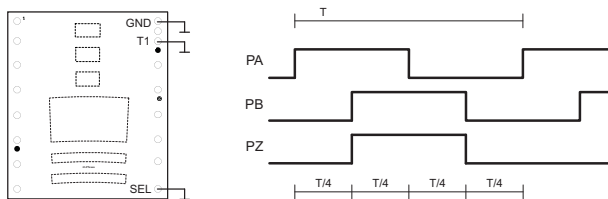

Figure 8: B-gated index ($T1 = \text{low}$),
x1 compared ($\text{SEL} = \text{low}$).

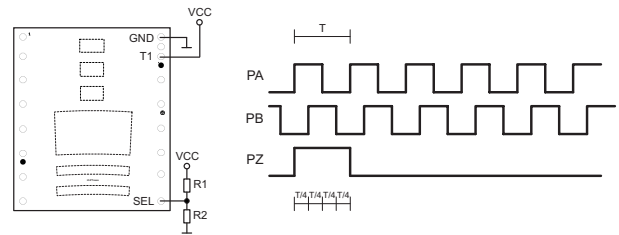

Figure 13: T-gated index ($T1 = \text{high}$),
x4 interpolated ($\text{SEL} = 25\% VCC$).

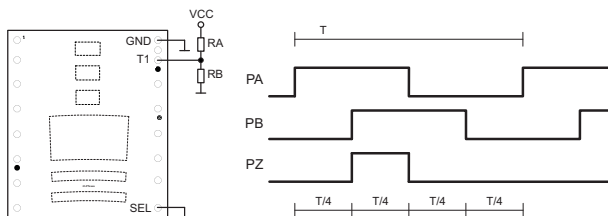

Figure 9: AB-gated index ($T1 = \text{open or } VCC/2$),
x1 compared ($\text{SEL} = \text{low}$).

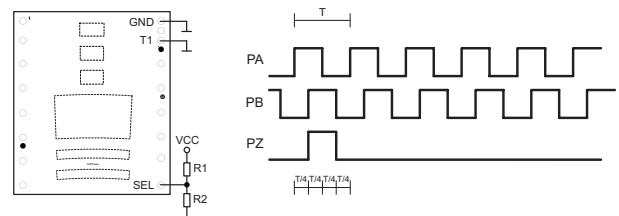

Figure 14: B-gated index ($T1 = \text{low}$),
x4 interpolated ($\text{SEL} = 25\% VCC$).

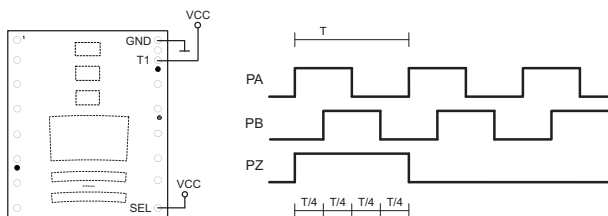

Figure 10: T-gated index ($T1 = \text{high}$),
x2 interpolated ($\text{SEL} = \text{high}$).

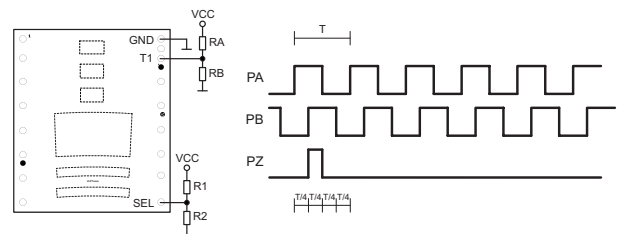

Figure 15: AB-gated index ($T1 = \text{open or } VCC/2$),
x4 interpolated ($\text{SEL} = 25\% VCC$).

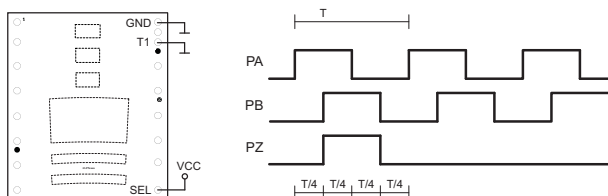

Figure 11: B-gated index ($T1 = \text{low}$),
x2 interpolated ($\text{SEL} = \text{high}$).

iC-PT H-Series

6-CH. PHASED ARRAY OPTO ENCODERS



Rev C2, Page 11/14

DEVICE OVERVIEW

Device	CPR native	Code Disc P/O Code	Material	Permissible Max. RPM	Typ. LED Current ¹		Comments
					iC-TL85	iC-TL46	

∅ 26 Series

iC-PT2656H	250	PT16FS 26-250_4	film ²	96,000			
	256	PT14HFS 26-256_4 PT14FS 26-256_4	film film ²	93,700	9 mA	6 mA	
iC-PT2650H	500	PT13HFS 26-500_4 PT13FS 26-500_4	film film ²	48,000	10 mA	7 mA	
	512	PT21HFS 26-512_4	film ²				
iC-PT2610H	1000	PT15HFS 26-1000_4 PT15S 26-1000_4	film glass ²	24,000	9 mA	6 mA	
	1024	PT20S 26-1024_4	glass ²	23,400			
iC-PT2613H	1250	PT06HFS 26-1250_4 PT06S 26-1250_4	film glass ²	19,200	11 mA	8 mA	
iC-PT2615H	1500	PT22HFS 26-1500_4	film	16,000			

∅ 33 Series

iC-PT3304H	360	PT23HFS 33-360_4	film	66,000			
iC-PT3350H	500	PT29HS 33-500_4	glass	48,000			
iC-PT3310H	1000	PT02HFS 33-1000_4	film	24,000	9 mA	6 mA	
		PT02S 33-1000_3	glass ²				
iC-PT3324H	1024	PT03HFS 33-1024_4	film	23,200	9 mA	7 mA	
		PT03S 33-1024_3	glass ²				
iC-PT3313H	1250	PT01HFS 33-1250_4	film	19,200	9 mA	6 mA	
		PT01S 33-1250_3	glass ²				
iC-PT3315H	1500	PT25HFS 33-1500_4	film	16,000			
iC-PT3318H	1800	PT26HFS 33-1800_4	film	13,300			
iC-PT3320H ³	2000						
iC-PT3348H ³	2048						
iC-PT3325H ³	2500						

∅ 39 Series

iC-PT3912H	512	PT18HFS 39-512_4	film	46,800	8 mA	5 mA	
		PT18S 39-512_4	glass ²				
iC-PT3910H	1000	PT10HFS 39-1000_4	film	24,000	8 mA	6 mA	
		PT10S 39-1000_4	glass ²				
iC-PT3924H	1024	PT11HFS 39-1024_4	film	23,400	8 mA	6 mA	
		PT11S 39-1024_4	glass ²				
iC-PT3948H	2048	PT12HFS 39-2048_4	film	11,700	10 mA	8 mA	
		PT12S 39-2048_4	glass ²				

¹ Controlled LED output current of IC (DC average); according to Elec. Char. No. 502.

² Code disc design made for iC-PTxx series.

³ Refer to iC-PT33xxH [Encoder blue®](#) Series datasheet available separately.

Table 2: Device overview (availability on request).

TEST MODE

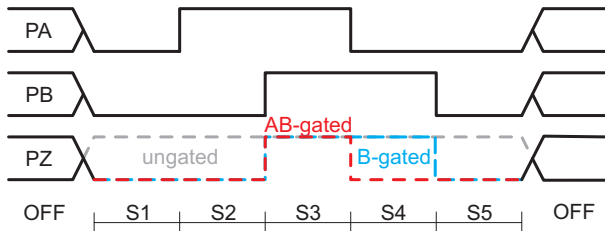

Figure 16: Output states during test mode
(SEL = low: x1 compared)

State	I(TIP)	I(TIN)	Function	Wiring Instruction
OFF	$I(\text{TIP}) \leq 10 \mu\text{A}$	$I(\text{TIN}) \leq 10 \mu\text{A}$	Normal operation	
S1	$I(\text{TIP}) \geq 190 \mu\text{A}$ $I(\text{TIP}) \approx 300 \mu\text{A}$	$I(\text{TIN}) \geq 190 \mu\text{A}$ $I(\text{TIN}) \approx 300 \mu\text{A}$	Test mode activation (low-level at PA, PB)	Pull-up TIP and TIN by 10 k Ω each to 5V.
S2	$I(\text{TIP}) \approx 700 \mu\text{A}$	$I(\text{TIN}) \approx 300 \mu\text{A}$	Force high-level at PA	Add pull-up to TIP of 4.7 k Ω to 5V.
S3	$I(\text{TIP}) \approx 700 \mu\text{A}$	$I(\text{TIN}) \approx 700 \mu\text{A}$	Force high-level at PA, PB, PZ	Add pull-up to TIN of 4.7 k Ω to 5V.
S4	$I(\text{TIP}) \approx 300 \mu\text{A}$	$I(\text{TIN}) \approx 700 \mu\text{A}$	Keep high-level at PB (and PZ if B-gated)	Disconnect 4k7 pull-up from TIP.
S5	$I(\text{TIP}) \approx 300 \mu\text{A}$	$I(\text{TIN}) \approx 300 \mu\text{A}$	(low-level at all outputs)	Disconnect 4k7 pull-up from TIN.
OFF	$I(\text{TIP}) \leq 10 \mu\text{A}$	$I(\text{TIN}) \leq 10 \mu\text{A}$	Normal operation	All pull-ups removed.

Table 3: Selection of output states.

DESIGN REVIEW: Notes On Chip Functions

PTxxxxH Chip release W		
No.	Function, Parameter/Code	Description and Application Hints
		Refer to former datasheet release A3, 2014.

Table 4: Design review

PTxxxxH Chip release W1, W2, W3		
No.	Function, Parameter/Code	Description and Application Hints
		None at time of printing.

Table 5: Design review

iC-PT H-Series

6-CH. PHASED ARRAY OPTO ENCODERS



Rev C2, Page 13/14

APPLICATION NOTES

Application notes for iC-PT H-series devices are available separately.

REVISION HISTORY

Rel.	Rel. Date ¹	Chapter	Modification	Page
A3	2014-12-19	...	Exclusion of Encoder blue series (re. Features, Description, Elec.Char. 302, Table 5)	1,2,6,10

Rel.	Rel. Date ¹	Chapter	Modification	Page
A2	2014-11-06	...	Initial release	all

Rel.	Rel. Date ¹	Chapter	Modification	Page
B1	2016-08-01	PACKAGING INFORMATION	Chip layout supplemented, update of drawings (chip rel. W2)	3
		ELECTRICAL CHARACTERISTICS	Adaptions for chip releases W1, W2: Item 201: typ. UVW gain, item 303: min. value Block Z supplemented for test inputs	7
		TEST MODE	New chapter added	11

Rel.	Rel. Date ¹	Chapter	Modification	Page
B2	2018-10-10	DESCRIPTION	Native CPR of 500 added (for iC-PT3350H)	2
		ABSOLUTE MAXIMUM RATINGS	Redundant G008 (Ts) deleted	6
		ELECTRICAL CHARACTERISTICS	Figure 2 updated	8
		DEVICE OVERVIEW	PT3350H added; P/O code corrected for PT01S, PT02S, PT03S glass discs; Listing extended to Encoder blue [®] devices	11
		DESIGN REVIEW: Notes On Chip Functions	Updated to include chip rel. W3, and exclude chip rel. W	12

Rel.	Rel. Date ¹	Chapter	Modification	Page
C2	2021-10-09	PACKAGING INFORMATION	Sensor layout added for AOI, footnote with hyperlink to customer information	3
		PACKAGE DIMENSIONS	Update of package drawing and footnote	5
		ELECTRICAL CHARACTERISTICS	Item 101: conditions updated Item 201: correction of typical value Items 306: min limit, 307: max limit	7

iC-Haus expressly reserves the right to change its products, specifications and related supplements (together the Documents). A Datasheet Update Notification (DUN) gives details as to any amendments and additions made to the relevant Documents on our internet website www.ichaus.com/DUN and is automatically generated and shall be sent to registered users by email.

Copying – even as an excerpt – is only permitted with iC-Haus' approval in writing and precise reference to source.

The data and predicted functionality is intended solely for the purpose of product description and shall represent the usual quality and behaviour of the product. In case the Documents contain obvious mistakes e.g. in writing or calculation, iC-Haus reserves the right to correct the Documents and no liability arises insofar that the Documents were from a third party view obviously not reliable. There shall be no claims based on defects as to quality and behaviour in cases of insignificant deviations from the Documents or in case of only minor impairment of usability.

No representations or warranties, either expressed or implied, of merchantability, fitness for a particular purpose or of any other nature are made hereunder with respect to information/specification resp. Documents or the products to which information refers and no guarantee with respect to compliance to the intended use is given. In particular, this also applies to the stated possible applications or areas of applications of the product.

iC-Haus products are not designed for and must not be used in connection with any applications where the failure of such products would reasonably be expected to result in significant personal injury or death (*Safety-Critical Applications*) without iC-Haus' specific written consent. Safety-Critical Applications include, without limitation, life support devices and systems. iC-Haus products are not designed nor intended for use in military or aerospace applications or environments or in automotive applications unless specifically designated for such use by iC-Haus.

iC-Haus conveys no patent, copyright, mask work right or other trade mark right to this product. iC-Haus assumes no liability for any patent and/or other trade mark rights of a third party resulting from processing or handling of the product and/or any other use of the product.

Software and its documentation is provided by iC-Haus GmbH or contributors "AS IS" and is subject to the ZVEI General Conditions for the Supply of Products and Services with iC-Haus amendments and the ZVEI Software clause with iC-Haus amendments (www.ichaus.com/EULA).

¹ Release Date format: YYYY-MM-DD

iC-PT H-Series

6-CH. PHASED ARRAY OPTO ENCODERS



Rev C2, Page 14/14

ORDERING INFORMATION

Type	Package	Options	Order Designation
iC-PTnnnnH	32-pin optoQFN, 5 mm x 5 mm, 0.9 mm thickness RoHS compliant	nnnn = device version	iC-PTnnnnH oQFN32-5x5
Code Disc	film disc 0.18 mm	nn = design number aa = diameter xxxx = AB pulse count ID u = UVW pulse count ID	PTnnHFS aa-xxxx_u
Evaluation Kit	Kit with Scanner Module IC273 (61 mm x 64 mm), LED Module IC274 and Code Disc	nnnn = device version	iC-PTnnnn EVAL IC273
Illumination	Infrared LED module (28 mm x 29 mm)	assembled with iC-SD85 (850 nm)	iC-SD85 EVAL IC274
	Blue LED module (28 mm x 29 mm)	assembled with iC-TL46 (460 nm)	iC-TL46 EVAL IC274
Mother Board	Adapter PCB (80 mm x 110 mm)	incl. ribbon cable	iC277 EVAL IC277

Please send your purchase orders to our order handling team:

Fax: +49 (0) 61 35 - 92 92 - 692
E-Mail: dispo@ichaus.com

For technical support, information about prices and terms of delivery please contact:

iC-Haus GmbH
Am Kuemmerling 18
D-55294 Bodenheim
GERMANY

Tel.: +49 (0) 61 35 - 92 92 - 0
Fax: +49 (0) 61 35 - 92 92 - 192
Web: <http://www.ichaus.com>
E-Mail: sales@ichaus.com

Appointed local distributors: http://www.ichaus.com/sales_partners