

iC212

HIGHSPEED PHOTORECEIVER



Rev C3, Page 1/10

FEATURES

- ◆ Bandwidth DC to 1.4 GHz
- ◆ Si PIN photodiode, \varnothing 0.2 mm for "No Slow Tail" (NST) option
- ◆ InGaAs photodiode, \varnothing 0.1 mm for "Near Infrared" (NIR) option
- ◆ Spectral response range $\lambda = 320$ to 1000 nm (NST)
- ◆ Spectral response range $\lambda = 800$ to 1800 nm (NIR)
- ◆ Amplifier transimpedance (gain) 3.125 V/mA
- ◆ Max. conversion gain 1.25 V/mW @ 700 nm (NST)
- ◆ Max. conversion gain 3.25 V/mW @ 1500 nm (NIR)

APPLICATIONS

- ◆ Fast pulse and transient measurement
- ◆ Optical front-end for oscilloscopes

DEVICE

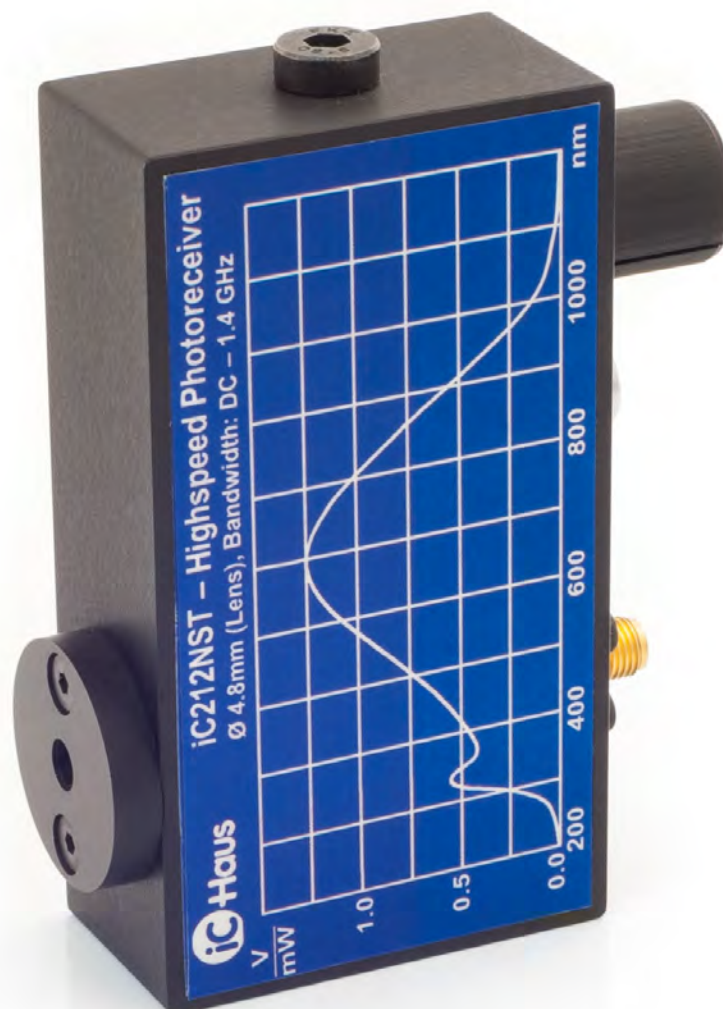

iC212

HIGHSPEED PHOTORECEIVER



Rev C3, Page 2/10

DESCRIPTION

The iC-Haus Highspeed Photoreceiver iC212 has been developed for optical high speed measurement. With its bandwidth ranging from DC up to 1.4 GHz it detects photo signals from constant light to high speed with rise times down to 200 ps. The iC212 Highspeed Photoreceiver also features offset adjustment to compensate DC levels of the input signal.

The photodiode used with the standard "no slow tail" (NST, blue label) version covers a spectral range from 320 to 1000 nm with an active area diameter of about \varnothing 0.2 mm, which is increased by a \varnothing 4.6 mm lens, re-

sulting in an effective usable area of typical 12.5 mm². The Highspeed Photoreceiver is able to detect power levels in the sub mW range at GHz speed.

The "Near Infrared" (NIR, orange label) version covers a spectral range from ca. 800 to 1800 nm.

The iC212 Highspeed Photoreceiver comes with M6 mounting holes for integration in optical bench systems and an optional fiber-optic input adapter for optical fiber coupling.

ABSOLUTE MAXIMUM RATINGS

Beyond these values damage may occur; device operation is not guaranteed.

Item No.	Symbol	Parameter	Conditions			Unit
				Min.	Max.	
G001	Pmax	Optical Input Power			10	mW
G002	Vs	Power Supply Voltage			20	V

ELECTRICAL CHARACTERISTICS

Test Conditions: Vs = 18 V, Ta = 25 °C*, System Impedance 50 Ω

Item No.	Symbol	Parameter	Conditions				Unit
				Min.	Typ.	Max.	
Gain							
101	A	Amplifier Transimpedance Conversion Gain	50 Ω load; NST: λ = 700 nm NIR: λ = 1500 nm		3.125 1.25 3.25		V/mA V/mW V/mW
Frequency Response							
201	fmax	Upper Cut-Off Frequency	-3 dB		1.4		Ghz
202	Δ A	Gain Flatness			\pm 1		dB
203	tr	Rise Time	10 to 90%		280		ps
204	tpd	Propagation Delay	optical in => electrical out, 50% to 50%		750		ps
Detector							
301	d	Active Area Diameter	NST NIR		0.2 0.1		mm mm
302	Aeff	Effective Active Area	4.6 mm lens		12.5		mm ²
303	λ	Spectral Range	NST NIR	320 800		1000 1800	nm nm
304	Pmax	Max. Optical Input Power	NST: average NST: linear amplification @ 700 nm NIR: linear amplification @ 1500 nm		10 770 320		mW μ W μ W
305	NEP	Noise equivalent power	including amplifier noise, f = 1 GHz		115		pW/ \sqrt Hz
Output							
401	Rout	Output Impedance			50		Ω
402	Vout	Output Voltage Swing	50 Ω load, for linear amplification	-0.3		1.0	V
403	Vos	Offset Voltage (adjustable) [†]	DC offset cancellation	-1.25		0.15	V
404	Pos	Offset (adjustable) [†]	equivalent optical power	-92		750	μ W
405	twu	Warm-Up Time	stable offset voltage		30		min

iC212

HIGHSPEED PHOTORECEIVER



Rev C3, Page 3/10

ELECTRICAL CHARACTERISTICS

Test Conditions: $V_s = 18\text{ V}$, $T_a = 25\text{ }^\circ\text{C}^*$, System Impedance $50\ \Omega$

Item No.	Symbol	Parameter	Conditions				Unit
				Min.	Typ.	Max.	
Power Supply							
501	Vs	Supply Voltage				18	V
502	Is	Supply Current		150			mA

* Caution! Even during regular operation, the aluminum case of the photoreceiver may heat up to $40\text{ }^\circ\text{C}$ max.

† The output is clipped to -0.5 V , if the offset voltage is less than 0.5 V and no DC light is present.

iC212

HIGHSPEED PHOTORECEIVER



Rev C3, Page 4/10

CONTENTS

The purchased parts package includes

- Highspeed Photoreceiver iC212 (picture shows standard NST option)
- Power adapter (230 VAC)
- Coaxial cable with SMA plugs
- SMA to BNC adapter
- Fiber adapter



Figure 1: Box contents

DIMENSIONS

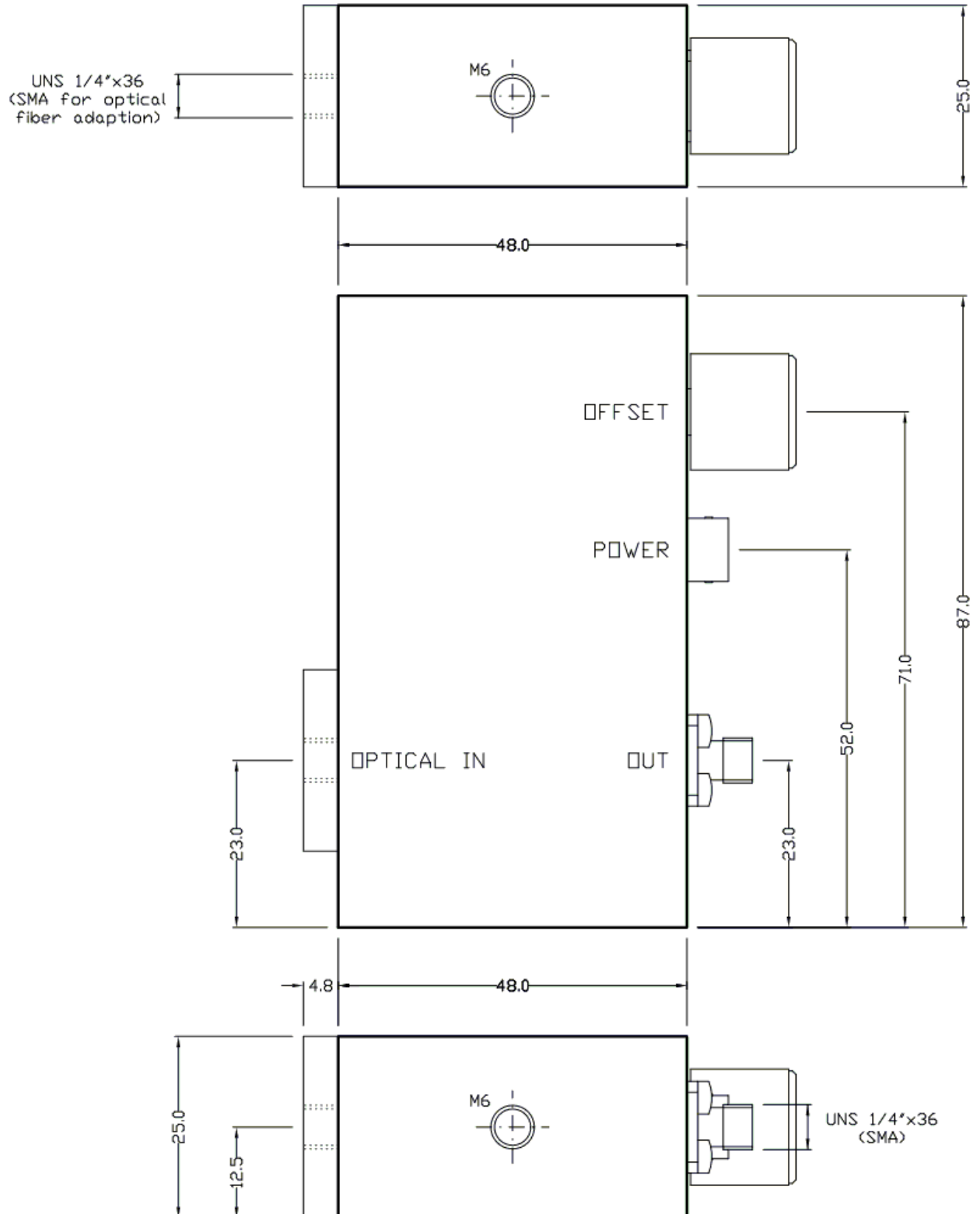

Figure 2: Case dimensions (all units in mm)

CONNECTORS

Input	
NST	Optical, micro bench adaption - Free-space measurement (default) - SMA fiber adapter (optional)
NIR	FC/PC fiber adapter with integrated photodiode - Lens cap for free-space measurement (default)
Output	SMA Connector
Power Supply	DC power connector, 5.5 mm/2.1 mm +: Vs+ -: Vs-

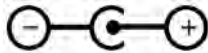

Table 1: Connectors

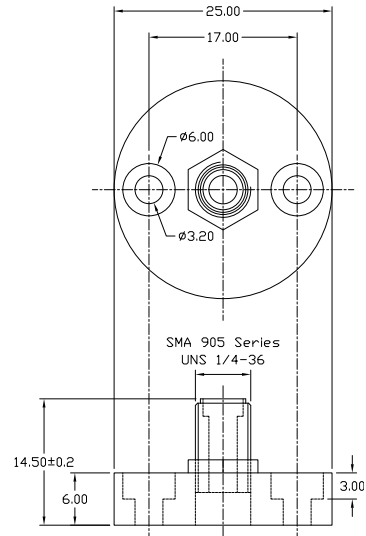

Figure 3: SMA fiber adapter (NST version only)

RESPONSE

Standard "No Slow Tail" (NST) option

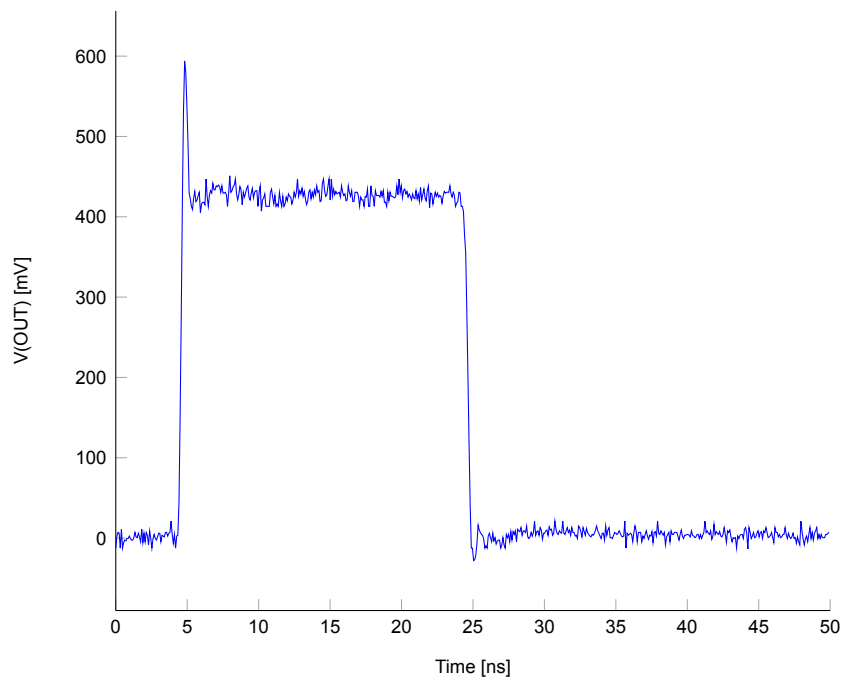

Figure 4: Pulse response (NST)

"Near Infrared" (NIR) option

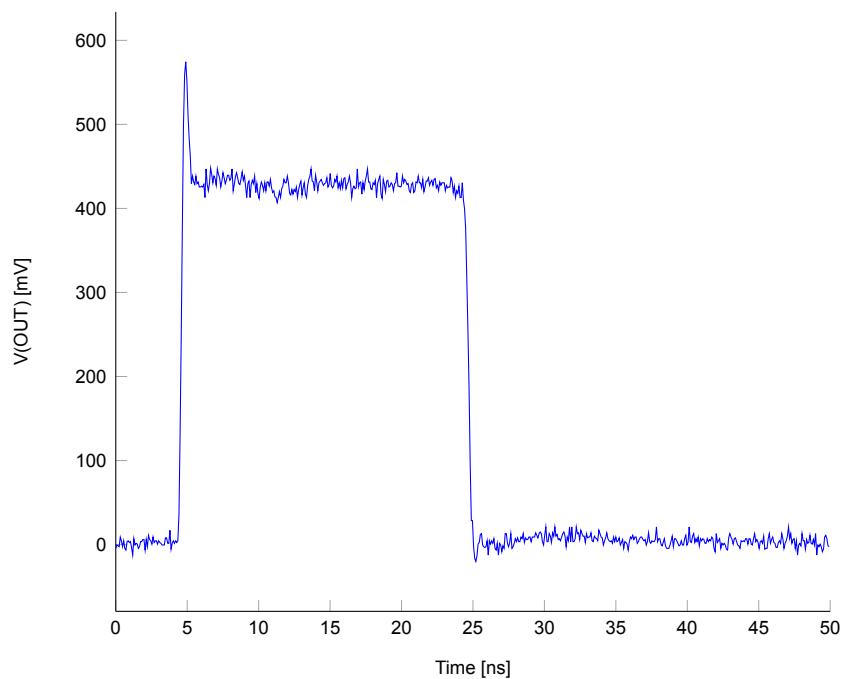

Figure 5: Pulse response (NIR)

Spectral response

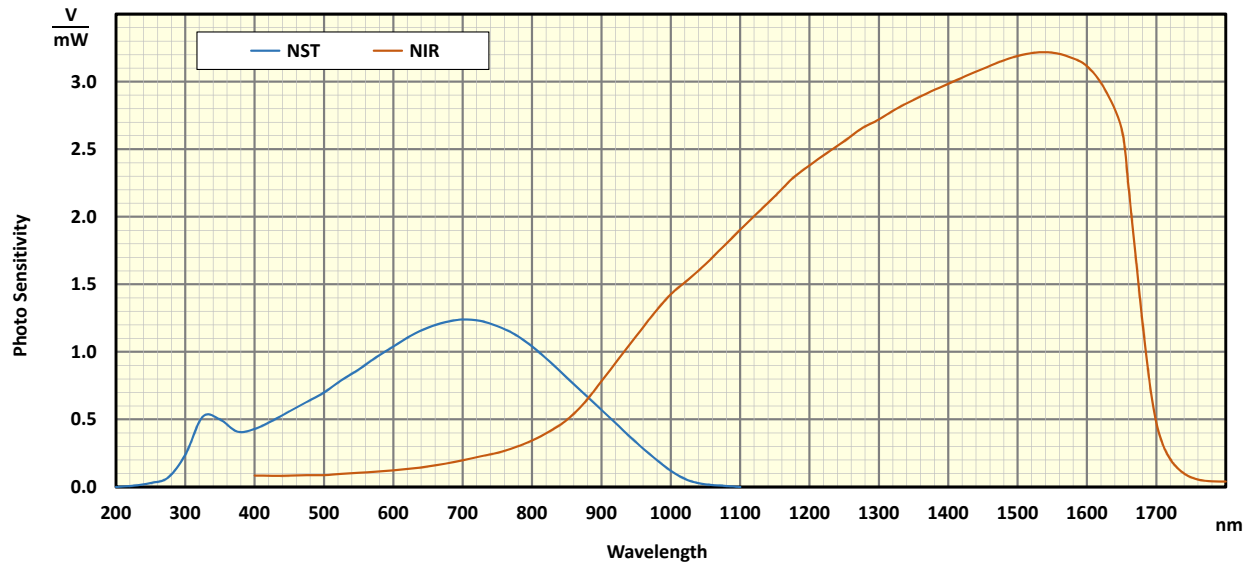

Figure 6: Spectral response

DISPOSAL INSTRUCTIONS

Electrical and electronic equipment must not be disposed with consumers waste. Its components must be recycled or disposed apart from each other. Otherwise contaminative and hazardous substances can pollute our environment. The customer is committed by law to dispose electrical and electronic devices to the producer, the dealer or public collecting points at the end

of the devices lifetime for free. For simplification for the customer and to ensure the environmental protection, iC-Haus requests the customer to send back the iC212 free of charge after lifetime. iC-Haus will disassemble and recycle all parts properly and in accordance with the applicable standards.

REVISION HISTORY

Rel.	Rel. Date*	Chapter	Modification	Page
B1	2015-07-30	FEATURES	NIR version added	1
		DEVICE	New standard NST version shown	1
		DESCRIPTION	NIR version added	2
		ELECTRICAL CHARACTERISTICS	NIR version added	2
		CONTENTS	New standard NST version shwon	4
		DIMENSIONS	Fiber adapter added	5
		CONNECTORS	Lens dropped	6
		RESPONSE	NIR version added	8
		APPLICATION NOTES	Equipment used: iC227, HV1M, HG2D added	15
		ORDERING INFORMATION	NIR version added	16

Rel.	Rel. Date*	Chapter	Modification	Page
C1	2019-03-15	DEVICE	New product photo	1
		ELECTRICAL CHARACTERISTICS	Single 18 V supply	3
		CONNECTORS	Pin configuration	6
		RESPONSE	Pulse response NIR added	8

Rel.	Rel. Date*	Chapter	Modification	Page
C2	2020-03-17	CONTENTS	New picture box contents	4
		CONNECTORS	Input NST/NIR updated	6
		RESPONSE	Pulse response x-axis scale corrected	7
		RESPONSE	New diagram spectral response	8
		APPLICATION NOTES	Application notes moved to seperate document	

Rel.	Rel. Date*	Chapter	Modification	Page
C3	2021-01-08	CONNECTORS	Table 1 and Figure 3 updated	6
		DISPOSAL INSTRUCTIONS	New	8
		ATTACHMENTS	CE Declaration added	11

iC-Haus expressly reserves the right to change its products, specifications and related supplements (together the Documents). A Datasheet Update Notification (DUN) gives details as to any amendments and additions made to the relevant Documents on our internet website www.ichaus.com/DUN and is automatically generated and shall be sent to registered users by email.

Copying – even as an excerpt – is only permitted with iC-Haus' approval in writing and precise reference to source.

The data and predicted functionality is intended solely for the purpose of product description and shall represent the usual quality and behaviour of the product. In case the Documents contain obvious mistakes e.g. in writing or calculation, iC-Haus reserves the right to correct the Documents and no liability arises insofar that the Documents were from a third party view obviously not reliable. There shall be no claims based on defects as to quality and behaviour in cases of insignificant deviations from the Documents or in case of only minor impairment of usability.

No representations or warranties, either expressed or implied, of merchantability, fitness for a particular purpose or of any other nature are made hereunder with respect to information/specification resp. Documents or the products to which information refers and no guarantee with respect to compliance to the intended use is given. In particular, this also applies to the stated possible applications or areas of applications of the product.

iC-Haus products are not designed for and must not be used in connection with any applications where the failure of such products would reasonably be expected to result in significant personal injury or death (*Safety-Critical Applications*) without iC-Haus' specific written consent. Safety-Critical Applications include, without limitation, life support devices and systems. iC-Haus products are not designed nor intended for use in military or aerospace applications or environments or in automotive applications unless specifically designated for such use by iC-Haus.

iC-Haus conveys no patent, copyright, mask work right or other trade mark right to this product. iC-Haus assumes no liability for any patent and/or other trade mark rights of a third party resulting from processing or handling of the product and/or any other use of the product.

Software and its documentation is provided by iC-Haus GmbH or contributors "AS IS" and is subject to the ZVEI General Conditions for the Supply of Products and Services with iC-Haus amendments and the ZVEI Software clause with iC-Haus amendments (www.ichaus.com/EULA).

* Release Date format: YYYY-MM-DD

ORDERING INFORMATION

Type	Options	Order Designation
iC212	Standard "No Slow Tail" (NST) "Near Infrared" (NIR)	iC212 iC212NIR

Please send your purchase orders to our order handling team:

Fax: +49 (0) 61 35 - 92 92 - 692
E-Mail: dispo@ichaus.com

For technical support, information about prices and terms of delivery please contact:

iC-Haus GmbH
Am Kuemmerling 18
D-55294 Bodenheim
GERMANY

Tel.: +49 (0) 61 35 - 92 92 - 0
Fax: +49 (0) 61 35 - 92 92 - 192
Web: <http://www.ichaus.com>
E-Mail: sales@ichaus.com

Appointed local distributors: http://www.ichaus.com/sales_partners

European Conformity Declaration

iC212 Highspeed Photoreceiver

Manufacturer:	iC-Haus GmbH Am Kuemmerling 18 55294 Bodenheim Phone: +49-6135-9292-0 https://www.ichaus.de
Product Description:	iC212 High-Speed Photoreceiver
Product Category:	Electrical equipment for measurement, control and laboratory use.

We hereby declare that the product conforms to the Restriction of certain Hazardous Substances Directive 2011/65/EU.

Date Issued:

September 15, 2020

Authorized Signature:



Dr. Heiner Flocke, CEO



iC-Haus GmbH
Am Kuemmerling 18
55294 Bodenheim
Germany
Tel +49 6135 9292 0
Fax +49 6135 9292 192
www.ichaus.com